



T8D24-V036



FEATURES

- **HD TVI - 1930 x 1088 @ 30fps**
- 1/2.7" Progressive Scan CMOS
- 3.6mm Fixed Lens
- 0.1 Lux @ F1.2 (AGC ON), 0 Lux with IR
- 24 IR LED
- IR distance up to 65ft / 20m
- Mechanical IR Cut Filter (ICR)
- DNR, Smart IR
- 3W
- 12V DC
- IP66 Rating

SPECIFICATIONS - Product Code: T8D24-V036

PIC: TVI-58

Model	T8D24-V036
Signal System	NTSC / PAL
Image Sensor	1/2.7" Progressive Scan CMOS
Horizontal Resolution	2.0MP
Effective Pixels	1930(H) x 1088(V)
Sync System	Internal
Video Frame Rate	NTSC: 1080P @ 30fps ; PAL: 1080P @ 25fps
HD Video Output	1 Analog HD Output
S/N Ratio	More than 52dB
Electronic Shutter	NTSC: 1/30~1/50,000 sec. ; PAL: 1/25~1/50,000 sec.
Minimum Illumination	0.1 Lux @ F1.2 (AGC ON), 0 Lux with IR
Day & Night	Built-in Mechanical IR Cut Filter (ICR)
IR LED	24pcs IR
IR Distance	65ft / 20m
Lens Type	3.6mm Fixed Lens (Angle of view: 90°)
Camera ID	On / Off (0~255)
AGC	Support
D/N Mode	Color / BW / Auto / EXT
White Balance	Auto/User/Push/8000K/6000K/4200K/3200K/HOLD
Privacy Mask	On / Off, maximum 2 zones
Motion Detection	On / Off
BLC	Support
Anti-flicker	On / Off
Language	English, Chinese
Functions	Mirror
Power Source	12V DC
Power Consumption	3W Max.
IP Rating	IP66
Operating Temperature	-40°F ~ 140°F / -40°C ~ 60°C
Humidity	90% or less (non-condensing)
Dimension	3.5(Ø) x 2.8(H) inches / 89.99(Ø) x 71.3(H) mm
Net Weight	0.9 lbs / 0.4 kg

*Specifications and appearance are subject to change without notice.

DIAGRAM

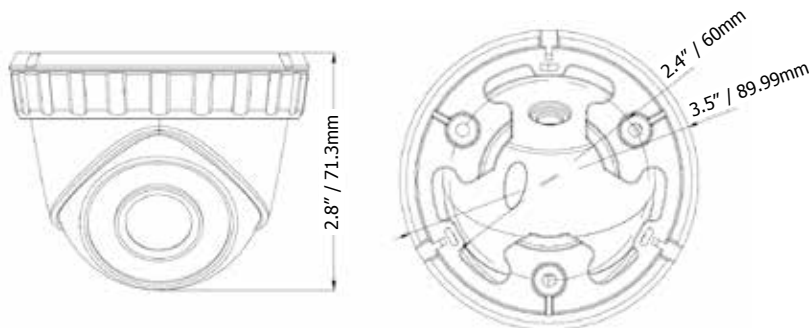

OPTIONAL ACCESSORIES



BK-113