



Network Video Recorder

User Manual

User Manual

About this Manual

This Manual is applicable to Network Video Recorder (NVR).

The Manual includes instructions for using and managing the product. Pictures, charts, images and all other information hereinafter are for description and explanation only. The information contained in the Manual is subject to change, without notice, due to firmware updates or other reasons. Please find the latest version in the company website.

Please use this user manual under the guidance of professionals.

Legal Disclaimer

TO THE MAXIMUM EXTENT PERMITTED BY APPLICABLE LAW, THE PRODUCT DESCRIBED, WITH ITS HARDWARE, SOFTWARE AND FIRMWARE, IS PROVIDED "AS IS", WITH ALL FAULTS AND ERRORS, AND OUR COMPANY MAKES NO WARRANTIES, EXPRESS OR IMPLIED, INCLUDING WITHOUT LIMITATION, MERCHANTABILITY, SATISFACTORY QUALITY, FITNESS FOR A PARTICULAR PURPOSE, AND NON-INFRINGEMENT OF THIRD PARTY. IN NO EVENT WILL OUR COMPANY, ITS DIRECTORS, OFFICERS, EMPLOYEES, OR AGENTS BE LIABLE TO YOU FOR ANY SPECIAL, CONSEQUENTIAL, INCIDENTAL, OR INDIRECT DAMAGES, INCLUDING, AMONG OTHERS, DAMAGES FOR LOSS OF BUSINESS PROFITS, BUSINESS INTERRUPTION, OR LOSS OF DATA OR DOCUMENTATION, IN CONNECTION WITH THE USE OF THIS PRODUCT, EVEN IF OUR COMPANY HAS BEEN ADVISED OF THE POSSIBILITY OF SUCH DAMAGES.

REGARDING TO THE PRODUCT WITH INTERNET ACCESS, THE USE OF PRODUCT SHALL BE WHOLLY AT YOUR OWN RISKS. OUR COMPANY SHALL NOT TAKE ANY RESPONSIBILITIES FOR ABNORMAL OPERATION, PRIVACY LEAKAGE OR OTHER DAMAGES RESULTING FROM CYBER ATTACK, HACKER ATTACK, VIRUS INSPECTION, OR OTHER INTERNET SECURITY RISKS; HOWEVER, OUR COMPANY WILL PROVIDE TIMELY TECHNICAL SUPPORT IF REQUIRED.

SURVEILLANCE LAWS VARY BY JURISDICTION. PLEASE CHECK ALL RELEVANT LAWS IN YOUR JURISDICTION BEFORE USING THIS PRODUCT IN ORDER TO ENSURE THAT YOUR USE CONFORMS THE APPLICABLE LAW. OUR COMPANY SHALL NOT BE LIABLE IN THE EVENT THAT THIS PRODUCT IS USED WITH ILLEGITIMATE PURPOSES.

IN THE EVENT OF ANY CONFLICTS BETWEEN THIS MANUAL AND THE APPLICABLE LAW, THE LATER PREVAILS

Regulatory Information

FCC Information

FCC compliance: This equipment has been tested and found to comply with the limits for a Class A digital device, pursuant to part 15 of the FCC Rules. These limits are designed to provide reasonable protection against harmful interference when the equipment is operated in a commercial environment. This equipment generates, uses, and can radiate radio frequency energy and, if not installed and used in accordance with the instruction manual, may cause harmful interference to radio communications. Operation of this equipment in a residential area is likely to cause harmful interference in which case the user will be required to correct the interference at his own expense.

FCC Conditions

This device complies with part 15 of the FCC Rules. Operation is subject to the following two conditions:

1. This device may not cause harmful interference.
2. This device must accept any interference received, including interference that may cause undesired operation.

EU Conformity Statement



This product and - if applicable - the supplied accessories too are marked with "CE" and comply therefore with the applicable harmonized European standards listed under the EMC Directive

2004/108/EC, the RoHS Directive 2011/65/EU.



2012/19/EU (WEEE directive): Products marked with this symbol cannot be disposed of as unsorted municipal waste in the European Union. For proper recycling, return this product to your local supplier upon the purchase of equivalent new equipment, or dispose of it at designated collection

points. For more information see: www.recyclethis.info



2006/66/EC (battery directive): This product contains a battery that cannot be disposed of as unsorted municipal waste in the European Union. See the product documentation for specific battery information. The battery is marked with this symbol, which may include lettering to indicate

cadmium (Cd), lead (Pb), or mercury (Hg). For proper recycling, return the battery to your supplier or to a designated collection point. For more information see: www.recyclethis.info

Industry Canada ICES-003 Compliance



This device meets the CAN ICES-3 (A)/NMB-3(A) standards requirements.

Safety Instruction

These instructions are intended to ensure that user can use the product correctly to avoid danger or property loss. The precaution measure is divided into “Warnings” and “Cautions”

Warnings: Serious injury or death may occur if any of the warnings are neglected.

Cautions: Injury or equipment damage may occur if any of the cautions are neglected.

	
Warnings Follow these safeguards to prevent serious injury or death.	Cautions Follow these precautions to prevent potential injury or material damage.



Warnings

- Proper configuration of all passwords and other security settings is the responsibility of the installer and/or end-user.
- In the use of the product, you must be in strict compliance with the electrical safety regulations of the nation and region. Please refer to technical specifications for detailed information.
- Input voltage should meet both the SELV (Safety Extra Low Voltage) and the Limited Power Source with 100~240 VAC or 12 VDC according to the IEC60950-1 standard. Please refer to technical specifications for detailed information.
- Do not connect several devices to one power adapter as adapter overload may cause over-heating or a fire hazard.
- Please make sure that the plug is firmly connected to the power socket.
- If smoke, odor or noise rise from the device, turn off the power at once and unplug the power cable, and then please contact the service center.

Preventive and Cautionary Tips

Before connecting and operating your device, please be advised of the following tips:

- Ensure unit is installed in a well-ventilated, dust-free environment.
- Unit is designed for indoor use only.
- Keep all liquids away from the device.
- Ensure environmental conditions meet factory specifications.
- Ensure unit is properly secured to a rack or shelf. Major shocks or jolts to the unit as a result of dropping it may cause damage to the sensitive electronics within the unit.
- Use the device in conjunction with an UPS if possible.
- Power down the unit before connecting and disconnecting accessories and peripherals.
- A factory recommended HDD should be used for this device.
- Improper use or replacement of the battery may result in hazard of explosion. Replace with the same or equivalent type only. Dispose of used batteries according to the instructions provided by the battery manufacturer.

Thank you for purchasing our product. If there is any question or request, please do not hesitate to contact dealer.
The figures in the manual are for reference only.

Product Key Features

General

- Connectable to network cameras, network dome and encoders.
- Connectable to the third-party network cameras like ACTI, Arecont, AXIS, Bosch, Brickcom, Canon, PANASONIC, Pelco, SAMSUNG, SANYO, SONY, Vivotek and ZAVIO, and cameras that adopt ONVIF or PSIA protocol.
- Connectable to the smart IP cameras.
- H.265/H.264/MPEG4 video formats
- PAL/NTSC adaptive video inputs.
- Each channel supports dual-stream.
- Independent configuration for each channel, including resolution, frame rate, bit rate, image quality, etc.
- The quality of the input and output record is configurable.

Local Monitoring

- HDMI and VGA outputs provided.
- HDMI Video output at up to 4K resolution and VGA video output at up to 2K resolution.
- Multiple screen display in live view is supported, and the display sequence of channels is adjustable.
- Live view screen can be switched in group. Manual switch and auto-switch are provided and the auto-switch interval is configurable.
- Quick setting menu is provided for live view.
- Motion detection, video tampering, video exception alert and video loss alert functions.
- Privacy mask.
- Multiple PTZ protocols supported; PTZ preset, patrol and pattern.
- Zooming in by clicking the mouse and PTZ tracing by dragging mouse.

HDD Management

- Up 2 SATA hard disks for 8ch and 16ch, and 1 SATA hard disk for 4ch series NVR.
- Up to 6TB storage capacity for each disk supported.
- Supports 8 network disks (NAS/IP SAN disk).
- Supports S.M.A.R.T. and bad sector detection.
- HDD group management.
- Supports HDD standby function.
- HDD property: redundancy, read-only, read/write (R/W).
- HDD quota management; different capacity can be assigned to different channel.

Recording and Playback

- Holiday recording schedule configuration.
- Continuous and event video recording parameters.
- Multiple recording types: manual, continuous, alarm, motion, motion | alarm, motion & alarm and VCA.
- 8 recording time periods with separated recording types.
- Pre-record and post-record for alarm, motion detection for recording, and pre-record time for schedule and manual recording.
- Searching record files by events (alarm input/motion detection).
- Tag adding for record files, searching and playing back by tags.
- Locking and unlocking record files.
- Local redundant recording.

- Provide new playback interface with easy and flexible operation.
- Searching and playing back record files by channel number, recording type, start time, end time, etc.
- Smart search for the selected area in the video.
- Zooming in when playback.
- Reverse playback of multi-channel.
- Supports pause, play reverse, speed up, speed down, skip forward, and skip backward when playback, and locating by dragging the mouse.
- Supports thumbnails view and fast view during playback.
- Up to 16-ch synchronous playback at 1080p real time.
- Supports enabling H.264+ to ensure high video quality with lowered bitrate.

Backup

- Export video data by USB and SATA.
- Export video clips when playback.
- Management and maintenance of backup devices.
- Either Normal or Hot Spare working mode is configurable to constitute an N+1 hot spare system.

Alarm and Exception

- Configurable arming time of alarm input/output.
- Alarm for video loss, motion detection, tampering, abnormal signal, video input/output standard mismatch, illegal login, network disconnected, IP confliction, abnormal record, HDD error, and HDD full, etc.
- VCA detection alarm is supported.
- VCA search for face detection, vehicle plate, behavior analysis, people counting and heat map.
- Alarm triggers full screen monitoring, audio alarm, notifying surveillance center, sending email and alarm output.
- Automatic restore when system is abnormal.

Other Local Functions

- Operable by front panel, mouse, remote control, or control keyboard.
- Three-level user management; admin user is allowed to create many operating accounts and define their operating permission, which includes the limit to access any channel.
- Operation, alarm, exceptions and log recording and searching.
- Manually triggering and clearing alarms.
- Import and export of device configuration information.

Network Functions

- One self-adaptive 10M/100M/1000M network interface for 8ch and 16ch models.
- One self-adaptive 10M/100M network interface for 4ch model.
- Four independent PoE network interfaces are provided for 4ch models, eight independent PoE network interfaces for the 8ch models, and sixteen independent PoE network interfaces for the 16ch models.
- IPv6 is supported.
- TCP/IP protocol, DHCP, DNS, DDNS, NTP, SADP, SMTP, SNMP, NFS, and iSCSI are supported.
- TCP, UDP and RTP for unicast.
- Auto/Manual port mapping by UPnP™.
- Extranet access by SIMPLEDDNS.
- Support access by Cloud P2P
- Remote web browser access by HTTPS ensures high security.
- The ANR (Automatic Network Replenishment) function is supported, it enables the IP camera save the

recording files in the local storage when the network is disconnected, and synchronizes the files to the NVR when the network is resumed.

- Remote reverse playback via RTSP.
- Supports accessing by the platform via ONVIF.
- Remote search, playback, download, locking and unlocking of the record files, and support downloading files broken transfer resume.
- Remote parameters setup; remote import/export of device parameters.
- Remote viewing of the device status, system logs and alarm status.
- Remote keyboard operation.
- Remote locking and unlocking of control panel and mouse.
- Remote HDD formatting and program upgrading.
- Remote system restart and shutdown.
- Alarm and exception information can be sent to the remote host
- Remotely start/stop recording.
- Remotely start/stop alarm output.
- Remote PTZ control.
- Virtual host function is provided to get access and manage the IP camera directly.
- Two-way audio and voice broadcasting.
- Embedded WEB server.

TABLE OF CONTENTS

Product Key Features	6
Chapter 1 Introduction	13
1.1 Front Panel	14
1.2 IR Remote Control Operations	15
1.3 USB Mouse Operation	19
1.4 Input Method Description.....	20
1.5 Rear Panel	21
Chapter 2 Getting Started	23
2.1 Starting Up and Shutting Down the NVR.....	24
2.2 Activating Your Device	25
2.3 Using the Unlock Pattern for Login.....	26
2.3.1 Configuring the Unlock Pattern	26
2.3.2 Logging in via Unlock Pattern	28
2.4 Using Wizard for Basic Configuration	29
2.5 Login and Logout	33
2.5.3 User Login	33
2.5.4 User Logout	33
2.6 Adding and Connecting the IP Cameras	35
2.6.1 Activating the IP Camera	35
2.6.2 Adding the Online IP Cameras.....	36
2.6.3 Editing the Connected IP Cameras and Configuring Customized Protocols	40
2.6.4 Editing IP Cameras Connected to the PoE Interfaces	42
Chapter 3 Live View	44
3.1 Introduction of Live View	45
3.2 Operations in Live View Mode.....	46
3.2.1 Front Panel Operation on Live View.....	46
3.2.2 Using the Mouse in Live View.....	46
3.2.3 Using an Auxiliary Monitor	47
3.2.4 Quick Setting Toolbar in Live View Mode	48
3.3 Adjusting Live View Settings	50
3.4 Channel-zero Encoding	52
Chapter 4 PTZ Controls	53
4.1 Configuring PTZ Settings.....	54
4.2 Setting PTZ Presets, Patrols & Patterns.....	55
4.2.1 Customizing Presets.....	55
4.2.2 Calling Presets	55
4.2.3 Customizing Patrols.....	56
4.2.4 Calling Patrols	57
4.2.5 Customizing Patterns	58
4.2.6 Calling Patterns.....	58
4.2.7 Customizing Linear Scan Limit	59
4.2.8 Calling Linear Scan	60

4.2.9	One-touch Park	60
4.3	PTZ Control Panel.....	62
Chapter 5	Recording Settings.....	63
5.1	Configuring Parameters.....	64
5.2	Configuring Recording Schedule	67
5.3	Configuring Motion Detection Recording.....	71
5.4	Configuring Alarm Triggered Recording.....	73
5.5	Manual Recording	75
5.6	Configuring Holiday Recording	76
5.7	Configuring Redundant Recording.....	78
5.8	Configuring HDD Group for Recording.....	80
5.9	Files Protection.....	81
5.9.1	Locking the Recording Files.....	81
5.9.2	Setting HDD Property to Read-only	83
Chapter 6	Playback.....	85
6.1	Playing Back Record Files	86
6.1.1	Instant Playback.....	86
6.1.2	Playing Back by Normal Search	86
6.1.3	Playing back by Smart Playback.....	89
6.1.4	Playing Back by Event Search	92
6.1.5	Playing Back by Tag	93
6.1.6	Playing Back by Sub-periods.....	96
6.1.7	Playing Back by System Logs	96
6.1.8	Playing Back External File	98
6.2	Auxiliary Functions of Playback	99
6.2.1	Playing Back Frame by Frame.....	99
6.2.2	Thumbnails View.....	99
6.2.3	Fast View	100
6.2.4	Digital Zoom.....	100
6.2.5	File Management	101
Chapter 7	Backup	102
7.1	Backing up Record Files	103
7.1.1	Quick Export.....	103
7.1.2	Backing up by Normal Video/Picture Search.....	105
7.1.3	Backing up by Event Search	107
7.1.4	Backing up Video Clips	108
7.2	Managing Backup Devices	109
7.3	Hot Spare Device Backup.....	110
7.3.1	Setting Hot Spare Device.....	110
7.3.2	Setting Working Device	111
7.3.3	Managing Hot Spare System.....	111
Chapter 8	Alarm Settings	114
8.1	Setting Motion Detection Alarm.....	115
8.2	Setting Sensor Alarms	117

8.3	Detecting Video Loss Alarm.....	120
8.4	Detecting Video Tampering Alarm	121
8.5	Handling Exceptions Alarm.....	123
8.6	Setting Alarm Response Actions	124
8.7	Triggering or Clearing Alarm Output Manually	127
Chapter 9	VCA Alarm.....	128
9.1	Face Recognition.....	129
9.2	Face Detection.....	129
9.3	Line Crossing Detection	130
9.4	Intrusion Detection	133
9.5	Region Entrance Detection	135
9.6	Region Exiting Detection	136
9.7	Loitering Detection.....	136
9.8	People Gathering Detection.....	136
9.9	Fast Moving Detection	136
9.10	Parking Detection	137
9.11	Unattended Baggage Detection	137
9.12	Object Removal Detection.....	137
9.13	Audio Exception Detection	137
9.14	Sudden Scene Change Detection.....	138
9.15	Defocus Detection	139
9.16	PIR Alarm.....	139
Chapter 10	VCA Search	140
10.1	Face Search	141
10.2	Behavior Search	143
10.3	People Counting	144
10.4	Heat Map.....	145
Chapter 11	Network Settings	147
11.1	Configuring General Settings	148
11.2	Configuring Advanced Settings.....	149
11.2.1	Configuring Cloud P2P.....	149
11.2.2	Configuring DDNS.....	149
11.2.3	Configuring NTP Server	153
11.2.4	Configuring SNMP.....	154
11.2.5	Configuring More Settings.....	155
11.2.6	Configuring HTTPS Port	156
11.2.7	Configuring Email	158
11.2.8	Configuring NAT	159
11.2.9	Configuring Virtual Host	162
11.3	Checking Network Traffic	163
11.4	Configuring Network Detection	164
11.4.1	Testing Network Delay and Packet Loss.....	164
11.4.2	Exporting Network Packet.....	164
11.4.3	Checking the Network Status.....	165

11.4.4	Checking Network Statistics	166
Chapter 12	HDD Management.....	168
12.1	Initializing HDDs	169
12.2	Managing Network HDD	171
12.3	Managing HDD Group	173
12.3.1	Setting HDD Groups.....	173
12.3.2	Setting HDD Property.....	174
12.4	Configuring Quota Mode.....	176
12.5	Configuring Disk Clone	178
12.6	Checking HDD Status	180
12.7	HDD Detection.....	182
12.8	Configuring HDD Error Alarms	184
Chapter 13	Camera Settings	185
13.1	Configuring OSD Settings.....	186
13.2	Configuring Privacy Mask.....	187
13.3	Configuring Video Parameters	188
Chapter 14	NVR Management and Maintenance	189
14.1	Viewing System Information.....	190
14.2	Searching & Exporting Log Files	191
14.3	Importing/Exporting IP Camera Info.....	193
14.4	Importing/Exporting Configuration Files	194
14.5	Upgrading System.....	195
14.5.1	Upgrading by Local Backup Device	195
14.5.2	Upgrading by FTP	195
14.6	Restoring Default Settings.....	197
Chapter 15	Others.....	198
15.1	Configuring General Settings	199
15.2	Configuring DST Settings	200
15.3	Configuring More Settings	201
15.4	Managing User Accounts.....	202
15.4.1	Adding a User	202
15.4.2	Deleting a User	205
15.4.3	Editing a User	205
Chapter 16	Appendix	208
16.1	Glossary.....	209
16.2	Troubleshooting.....	210
16.3	List of Compatible IP Cameras.....	216

Chapter 1 Introduction

1.1 Front Panel

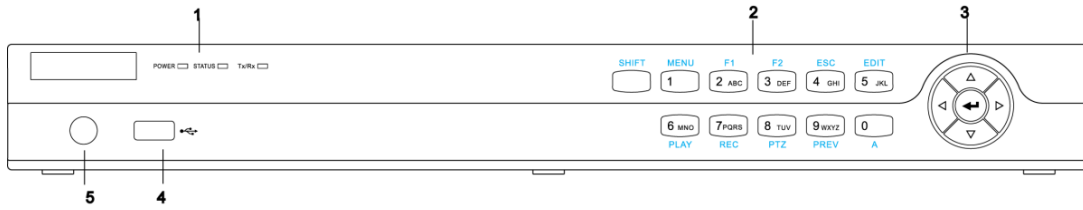

Figure 1. 1 Front Panel

Table 1. 1 Panel Description

No.	Name	Function Description	
1	POWER	Turns yellow when the device s running.	
	STATUS	Flickers red when data is being read from or written to HDD, and turns yellow when the SHIFT function is realized.	
	Tx/Rx	Flickers yellow when network connection is functioning properly.	
2	Composite Keys	SHIFT	Switches between the numeric or letter input and functions of the composite keys.
		1/MENU	Enters numeral “1”; Accesses the main menu interface.
		2/ABC/F1	Enters numeral “2”;
			Enters letters “ABC”;
			Uses the F1 button to select all items in a list field;
			Turns on/off PTZ light in PTZ Control mode, and use it to zoom out the image;
		3/DEF/F2	Switches between main and spot video output in live view or playback mode.
			Enters numeral “3”;
			Enters letters “DEF”;
			Uses the F2 button to change the tab pages;
		4/GHI/ESC	Zooms in the image in PTZ control mode.
			Enters numeral “4”;
			Enters letters “GHI”;
		5/JKL/EDIT	Exits and back to the previous menu.
			Enters numeral “5”;
			Enters letters “JKL”;
			Deletes characters before cursor;
		6/MNO/PLAY	Checks the checkbox and select the ON/OFF switch;
			Starts/stops record clipping in playback.
			Enters numeral “6”;
		7/PQRS/REC	Enters letters “MNO”;
Accesses to playback interface in Playback mode.			
Enters numeral “7”;			
		Enters letters “PQRS”;	
		Accesses to manual record interface;	

No.	Name	Function Description	
	8/TUV/PTZ	Manually enables/disables record.	
		Enters numeral “8”;	
		Enters letters “TUV”;	
	9/WXYZ/PREV	Accesses PTZ control interface.	
		Enters numeral “9”;	
		Enters letters “WXYZ”;	
	0/A	Multi-channel display in live view.	
		Enters numeral “0”;	
	3	DIRECTION	Shifts the input methods in the editing text field. (Upper and lowercase, alphabet, symbols or numeric input).
			Navigates between different fields and items in menus.
Uses the Up and Down buttons to speed up and slow down the playing of video files in Playback mode. The Left and Right button will select the next and previous record files.			
Cycles through channels in Live View mode.			
ENTER		Controls the movement of the PTZ camera in PTZ control mode.	
		Confirms selection in any of the menu modes.	
		Checks the checkbox.	
		Plays or pauses the playing of video files in Playback mode.	
		Advances the video by a single frame in single-frame Playback mode.	
		Stops/starts auto switch in Auto-switch mode.	
4	USB Interface	Universal Serial Bus (USB) ports for additional devices such as USB mouse and USB Hard Disk Drive (HDD).	
5	IR Receiver	Receiver for IR remote control.	

1.2 IR Remote Control Operations

The NVR may also be controlled with the included IR remote control, shown in Figure 1. 2.



Batteries (2×AAA) must be installed before operation.

The IR Remote is set at the factory to control the NVR (using default Device ID# 255) without any additional steps. Device ID# 255 is the default universal device identification number shared by the NVRs. You may also pair an IR Remote to a specific NVR by changing the Device ID#, as follows:

Pairing (Enabling) the IR Remote to a Specific DVR (optional)

You can pair an IR Remote to a specific DVR by creating a user-defined Device ID#. This feature is useful when using multiple IR Remotes and DVRs.

On the DVR:

1. Go to General > More Settings.
2. Type a number (255 digits maximum) into the Device No. field.
3. On the IR Remote:

4. Press the DEV button.
5. Use the Number buttons to enter the Device ID# that was entered into the DVR.
6. Press Enter button to accept the new Device ID#.

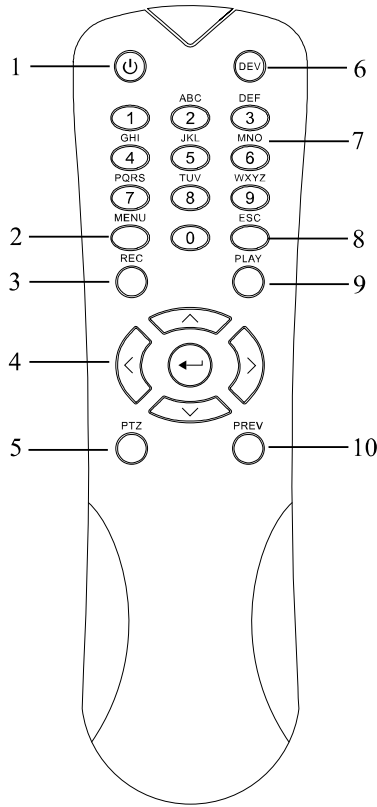

Figure 1. 2 Remote Control

- Unpairing (Disabling) an IR Remote from a DVR

To unpair an IR Remote from a DVR so that the unit cannot control any DVR functions, proceed as follows:

Press the DEV key on the IR Remote. Any existing Device ID# will be erased from the unit’s memory and it will no longer function with the DVR.

NOTE (Re)-enabling the IR Remote requires pairing to a DVR. See “Pairing the IR Remote to a Specific DVR (optional),” above.

The keys on the remote control closely resemble the ones on the front panel.

Table 1. 2 IR Remote Functions

No.	Name	Description
1	POWER	Power on/off the device.
		Power on/off the device by pressing and holding the button for 5 seconds.
2	MENU Button	Press the button to return to the main menu (after successful login).
		Press and hold the button for 5 seconds will turn off audible key beep.
		In PTZ Control mode, the MENU button will start wiper (if applicable).

No.	Name	Description
		In Playback mode, it is used to show/hide the control interface.
3	REC Button	Enter the Manual Record setting menu.
		In PTZ control settings, press the button and then you can call a PTZ preset by pressing Numeric button.
		It is also used to turn audio on/off in the Playback mode.
4	DIRECTION Button	Navigate between different fields and items in menus.
		In the Playback mode, the Up and Down button is used to speed up and slow down recorded video. The Left and Right button will select the next and previous record files.
		In Live View mode, these buttons can be used to cycle through channels.
		In PTZ control mode, it can control the movement of the PTZ camera.
	ENTER Button	Confirm selection in any of the menu modes.
		It can also be used to <i>tick</i> checkbox fields.
		In Playback mode, it can be used to play or pause the video.
		In single-frame Playback mode, pressing the button will advance the video by a single frame.
5	PTZ Button	In Auto-switch mode, it can be used to stop /start auto switch.
6	DEV	Enables/Disables Remote Control.
7	Alphanumeric Buttons	Switch to the corresponding channel in Live view or PTZ Control mode.
		Input numbers and characters in Edit mode.
		Switch between different channels in the Playback mode.
8	ESC Button	Back to the previous menu.
		Press for Arming/disarming the device in Live View mode.
9	PLAY Button	The button is used to enter the All-day Playback mode.
		It is also used to auto scan in the PTZ Control menu.
10	PREV Button	Switch between single screen and multi-screen mode.
		In PTZ Control mode, it is used to adjust the focus in conjunction with the A/FOCUS+ button.

Troubleshooting Remote Control:



Make sure you have installed batteries properly in the remote control. And you have to aim the remote control at the IR receiver in the front panel.

If there is no response after you press any button on the remote, follow the procedure below to troubleshoot.

Steps:

1. Go to Menu > Settings > General > More Settings by operating the front control panel or the mouse.
2. Check and remember NVR ID#. The default ID# is 255. This ID# is valid for all the IR remote controls.
3. Press the DEV button on the remote control.
4. Enter the NVR ID# you set in step 2.
5. Press the ENTER button on the remote.

If the Status indicator on the front panel turns blue, the remote control is operating properly. If the Status indicator

does not turn blue and there is still no response from the remote, please check the following:

1. Batteries are installed correctly and the polarities of the batteries are not reversed.
2. Batteries are fresh and not out of charge.
3. IR receiver is not obstructed.
4. No fluorescent lamp is used nearby

If the remote still can't function properly, please change a remote and try again, or contact the device provider.

1.3 USB Mouse Operation

A regular 3-button (Left/Right/Scroll-wheel) USB mouse can also be used with this NVR. To use a USB mouse:

1. Plug USB mouse into one of the USB interfaces on the front panel of the NVR.
2. The mouse should automatically be detected. If in a rare case that the mouse is not detected, the possible reason may be that the two devices are not compatible, please refer to the recommended the device list from your provider.

The operation of the mouse:

Table 1. 1 Description of the Mouse Control

Name	Action	Description
Left-Click	Single-Click	Live view: Select channel and show the quick set menu. Menu: Select and enter.
	Double-Click	Live view: Switch between single-screen and multi-screen.
	Click and Drag	PTZ control: pan, tilt and zoom. Video tampering, privacy mask and motion detection: Select target area. Digital zoom-in: Drag and select target area. Live view: Drag channel/time bar.
Right-Click	Single-Click	Live view: Show menu. Menu: Exit current menu to upper level menu.
Scroll-Wheel	Scrolling up	Live view: Previous screen. Menu: Previous item.
	Scrolling down	Live view: Next screen. Menu: Next item.

1.4 Input Method Description



Figure 1. 2 Soft Keyboard (1)



Figure 1. 3 Soft Keyboard (2)

Description of the buttons on the soft keyboard:

Table 1. 2 Description of the Soft Keyboard Icons

Icon	Description	Icon	Description
	Number		English letter
	Lowercase/Uppercase		Backspace
	Switch the keyboard		Space
	Positioning the cursor		Exit
	Symbols		Reserved

1.5 Rear Panel

Rear Panel 1

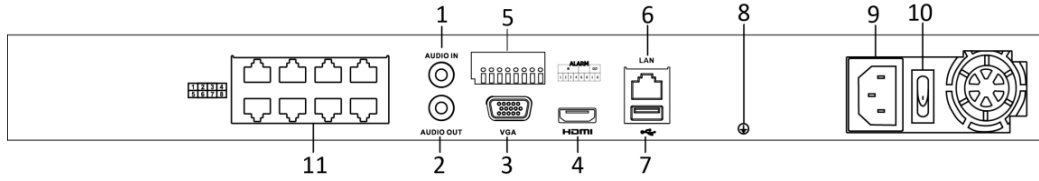

Figure 1. 3 Rear Panel 1

Table 1. 3 Panel Description

No.	Name	Description
1	Audio In	RCA connector for audio input.
2	Audio Out	RCA connector for audio output.
3	VGA Interface	DB9 connector for VGA output. Display local video output and menu.
4	HDMI Interface	HDMI video output connector.
5	ALARM IN	Connector for alarm input.
	ALARM OUT	Connector for alarm output.
6	LAN Network Interface	1 10/100/1000 Mbps self-adaptive Ethernet interface
7	USB Interface	Universal Serial Bus ports for additional devices such as USB mouse and USB Hard Disk Drive (HDD).
8	Ground	Ground (needs to be connected when NVR starts up).
9	Power Supply	100 to 240 VAC
10	Power Switch	Switch for turning on/off the device.
11	Network Interfaces with PoE function	Network interfaces for the cameras and to provide power over Ethernet.

Real Panel 2

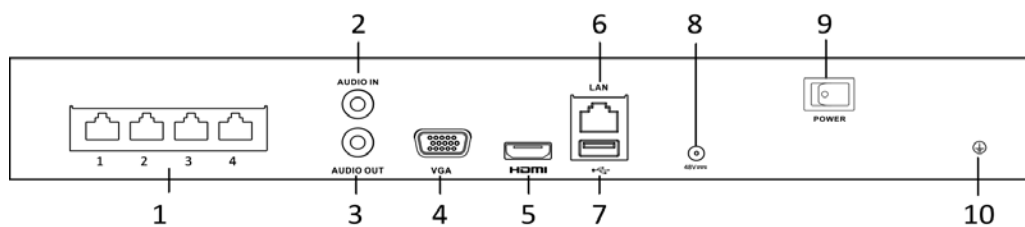

Figure 1. 4 Real Panel 2

Table 1. 4 Panel Description

No.	Name	Description
1	Network Interfaces with PoE function	Network interfaces for the cameras and to provide power over Ethernet.
2	Audio In	RCA connector for audio input.
3	Audio Out	RCA connector for audio output.
4	VGA Interface	DB9 connector for VGA output. Display local video output and menu.
5	HDMI Interface	HDMI video output connector.
6	LAN Network Interface	1 100 Mbps full-duplex Ethernet interface.
7	USB Interface	Universal Serial Bus ports for additional devices such as USB mouse and USB Hard Disk Drive (HDD).
9	Power Supply	48 VDC power supply
10	Ground	Ground (needs to be connected when NVR starts up).

Chapter 2 Getting Started

2.1 Starting Up and Shutting Down the NVR

Purpose:

Proper startup and shutdown procedures are crucial to expanding the life of the NVR.

Before you start:

Check that the voltage of the extra power supply is the same with the NVR's requirement, and the ground connection is working properly.

Starting up the NVR:

Steps:

1. Check the power supply is plugged into an electrical outlet. It is **HIGHLY** recommended that an Uninterruptible Power Supply (UPS) be used in conjunction with the device. The Power indicator LED on the front panel should be red, indicating the device gets the power supply.
2. Press the **POWER** button on the front panel. The Power indicator LED should turn blue indicating that the unit begins to start up.
3. After startup, the Power indicator LED remains blue. A splash screen with the status of the HDD appears on the monitor. The row of icons at the bottom of the screen shows the HDD status. 'X' means that the HDD is not installed or cannot be detected.

Shutting down the NVR

Steps:

There are two proper ways to shut down the NVR.

- **OPTION 1: Standard shutdown**

1. Enter the Shutdown menu.
Menu > Shutdown



Figure 2. 1 Shutdown Menu

2. Click the **Shutdown** button.
 3. Click the **Yes** button.
- **OPTION 2: By operating the front panel**
 1. Press and hold the POWER button on the front panel for 3 seconds.
 2. Enter the administrator's username and password in the dialog box for authentication.
 3. Click the **Yes** button.



Do not press the POWER button again when the system is shutting down.

Rebooting the NVR

In the Shutdown menu, you can also reboot the NVR.

Steps:

1. Enter the **Shutdown** menu by clicking Menu > Shutdown.
2. Click the **Logout** button to lock the NVR or the **Reboot** button to reboot the NVR.

2.2 Activating Your Device

Purpose:

For the first-time access, you need to activate the device by setting an admin password. No operation is allowed before activation. You can also activate the device via Web Browser, SADP or Client Software.

Steps:

1. Input the same password in the text field of **Create New Password** and **Confirm New Password**.

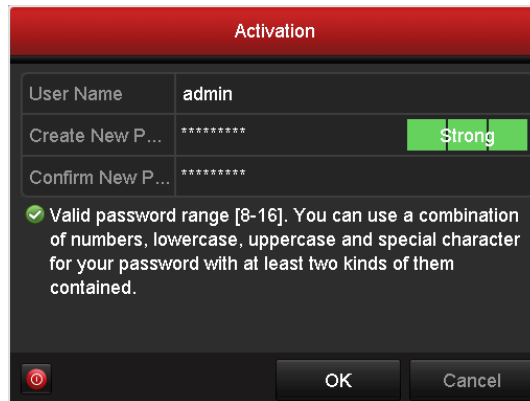

Figure 2. 2 Settings Admin Password

! STRONG PASSWORD RECOMMENDED—We highly recommend you create a strong password of your own choosing (Using a minimum of 8 characters, including at least three of the following categories: upper case letters, lower case letters, numbers, and special characters.) in order to increase the security of your product. And we recommend you reset your password regularly, especially in the high security system, resetting the password monthly or weekly can better protect your product.

2. Click **OK** to save the password and activate the device.



For the old version device, if you update it to the new version, the following dialog box will pop up once the device starts up. You can click **YES** and follow the wizard to set a strong password.



Figure 2. 3 Warning Dialog Box



If Admin's password is modified, the following menu pops up. Optionally, click the Yes button to duplicate the password to IP cameras that are connected with default protocol.



Figure 2. 4 Attention Interface

2.3 Using the Unlock Pattern for Login

For the Admin user, you can configure the unlock pattern for device login.

2.3.1 Configuring the Unlock Pattern

After the device is activated, you can enter the following interface to configure the device unlock pattern.

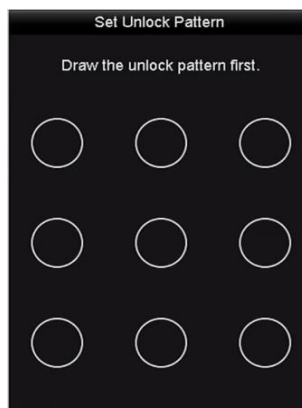

Figure 2. 5 Set Unlock Pattern

Steps:

1. Use the mouse to draw a pattern among the 9 dots on the screen. Release the mouse when the pattern is done.

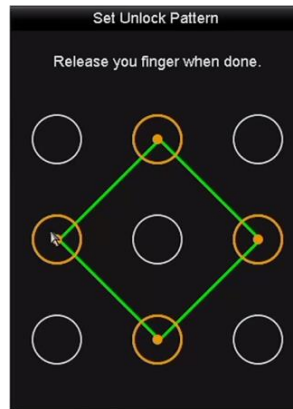

Figure 2. 6 Draw the Pattern



- Connect at least 4 dots to draw the pattern.
 - Each dot can be connected for once only.
2. Draw the same pattern again to confirm it. When the two patterns match, the pattern is configured successfully.

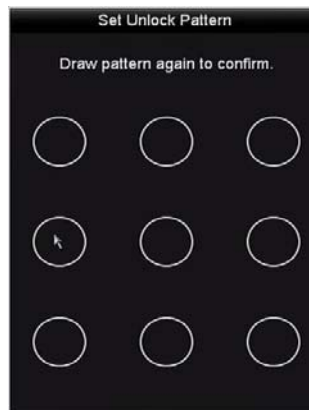

Figure 2. 7 Confirm the Pattern



If the two patterns are different, you must set the pattern again.

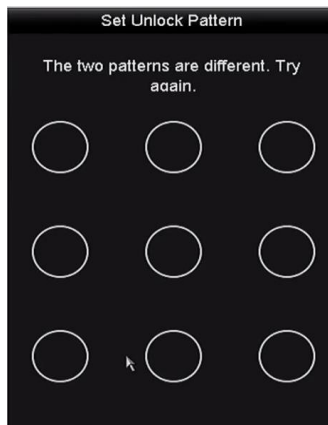

Figure 2. 8 Re-set the Pattern

2.3.2 Logging in via Unlock Pattern



- Only the *admin* user has the permission to unlock the device.
- Please configure the pattern first before unlocking. Please refer to Configuring the Unlock Pattern

Steps:

1. Right click the mouse on the screen and select the menu to enter the interface as shown in Figure 2.8.

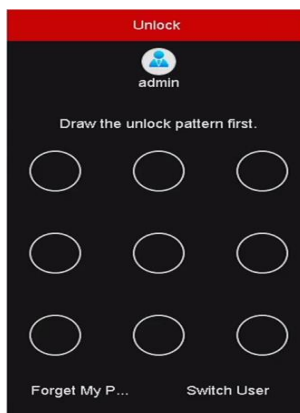

Figure 2. 9 Draw the Unlock Pattern

2. Draw the pre-defined pattern to unlock to enter the menu operation.



- If you have forgotten your pattern, you can select the **Forget My Pattern** or **Switch User** option to enter the normal login dialog box.
- When the pattern you draw is different from the pattern you have configured, you should try again.
- If you have drawn the wrong pattern for more than 5 times, the system will switch to the normal login mode automatically.



Figure 2. 10 Normal Login Dialog Box

2.4 Using Wizard for Basic Configuration

By default, the Setup Wizard starts once the NVR has loaded, as shown in Figure 2. 11.



Figure 2. 11 Start Wizard Interface

Operating the Setup Wizard:

1. The Setup Wizard can walk you through some important settings of the NVR. If you don't want to use the Setup Wizard at that moment, click the **Cancel** button. You can also choose to use the Setup Wizard next time by leaving the "Start wizard when the device starts?" checkbox checked.
2. Click **Next** button to enter the date and time settings window, as shown in Figure 2. 12.



Figure 2. 12 Date and Time Settings

3. After the time settings, click **Next** button which takes you back to the Network Setup Wizard window, as shown in the following figure.

NIC Type	10M/100M/1000M Self-adaptive
Enable DHCP	<input type="checkbox"/>
IPv4 Address	172 .6 .23 .190
IPv4 Subnet Mask	255 .255 .255 .0
IPv4 Default Gateway	172 .6 .23 .1
IPv6 Address 1	fe80::212:42ff:fed:ec46/64
IPv6 Address 2	
IPv6 Default Gateway	
MAC Address	00:12:42:fd:ec:46
MTU(Bytes)	1500
Preferred DNS Server	
Alternate DNS Server	
Internal NIC IPv4 Address	192 .168 .254 .1

Figure 2. 13 Network Setting



One self-adaptive 10M/100M/1000M network interface for 8ch and 16ch NVR. One self-adaptive 10M/100, network interface for 4ch NVR

4. Click **Next** button after you configured the basic network parameters. Then you will enter the **Cloud P2P** interface. Configure the Cloud P2P according to your need.

Wizard

Enable	<input checked="" type="checkbox"/>
Access Type	Cloud P2P
Server Address	dev.hicloudcam.com <input type="checkbox"/> Custom
Enable Stream Encr...	<input type="checkbox"/>
Verification Code	
Status	Offline

Previous
Next
Exit

Figure 2. 14 Advanced Network Parameters

5. Click **Next** button after you configured the basic network parameters. Then you will enter the **Advanced Network Parameter** interface. You can enable UPnP, DDNS and set other ports according to your need.

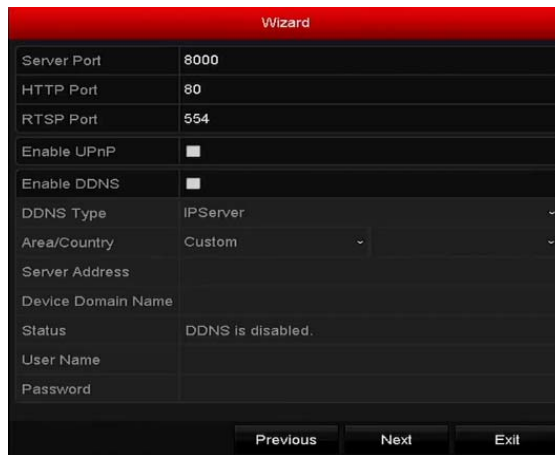

Figure 2. 15 Advanced Network Parameters

6. Click **Next** button after you configured the network parameters, which takes you to the **HDD Management** window, shown in Figure 2. 16.



Figure 2. 16 HDD Management

7. To initialize the HDD, click the **Init** button. Initialization removes all the data saved in the HDD.
8. Click **Next** button. You enter the **Adding IP Camera** interface.
9. Click **Search** to search the online IP Camera and the **Security** status shows whether it is active or inactive. Before adding the camera, make sure the IP camera to be added is in active status. If the camera is in inactive status, you can click the inactive icon of the camera to set the password to activate it. You can also select multiple cameras from the list and click the **One-touch Activate** to activate the cameras in batch. Click the **Add** to add the camera.

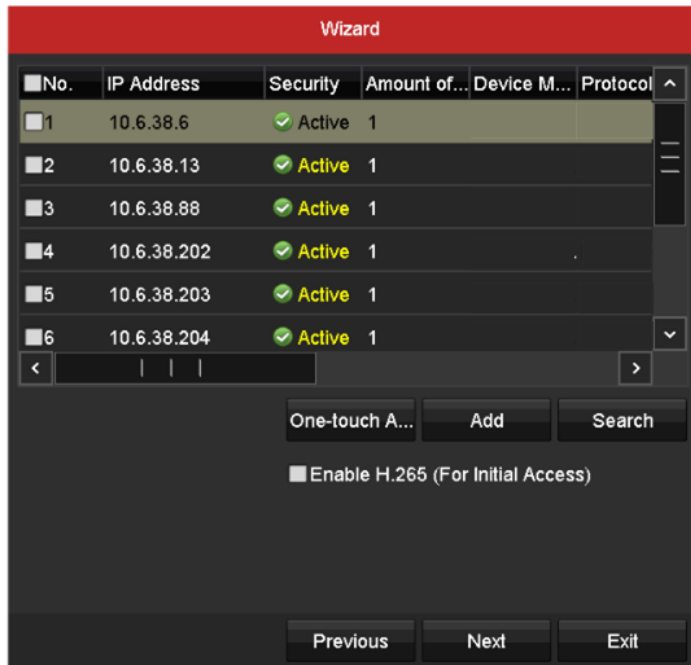

Figure 2. 17 Search for IP Cameras



When you check the checkbox of **Enable H.265**, the NVR can automatically switch to the H.265 stream of IP camera (which supports H.265 video format) for the initial access.

10. Click **Next** button. Configure the recording for the added IP Cameras.

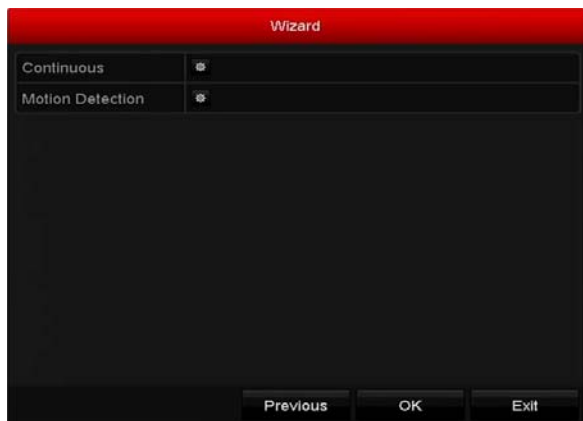

Figure 2. 18 Record Settings

11. Click **OK** to complete the startup Setup Wizard.

2.5 Login and Logout

2.5.3 User Login

Purpose:

If NVR has logged out, you must login the device before operating the menu and other functions.

Steps:

1. Select the **User Name** in the dropdown list.

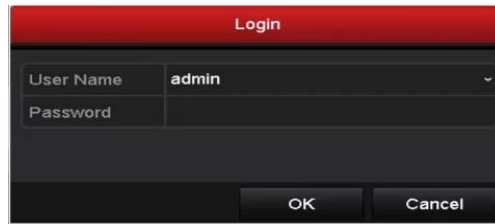

Figure 2. 19 Login Interface

2. Input **Password**.
3. Click **OK** to log in.



In the Login dialog box, if you enter the wrong password 7 times, the current user account will be locked for 60 seconds.

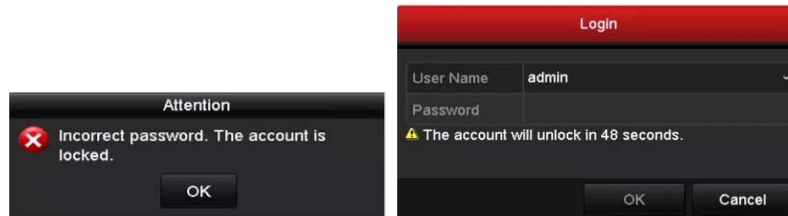

Figure 2. 20 User Account Protection

2.5.4 User Logout

Purpose:

After logging out, the monitor turns to the live view mode and if you want to perform any operations, you need to enter user name and password log in again.

Steps:

1. Enter the Shutdown menu.
Menu > Shutdown



Figure 2. 21 Logout

2. Click Logout.



After you have logged out the system, menu operation on the screen is invalid. It is required to input a user name and password to unlock the system.

2.6 Adding and Connecting the IP Cameras

2.6.1 Activating the IP Camera

Purpose:

Before adding the camera, make sure the IP camera to be added is in active status.

Steps:

1. Select the **Add IP Camera** option from the right-click menu in live view mode or click Menu> Camera> Camera to enter the IP camera management interface.

For the IP camera detected online in the same network segment, the **Password** status shows whether it is active or inactive.

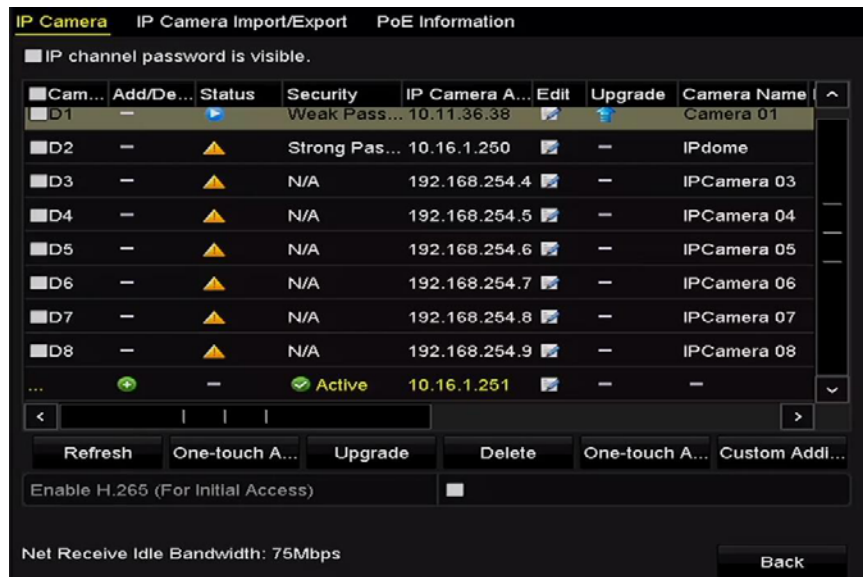

Figure 2. 22 IP Camera Management Interface

2. Click the inactive icon of the camera to enter the following interface to activate it. You can also select multiple cameras from the list and click the **One-touch Activate** to activate the cameras in batch.

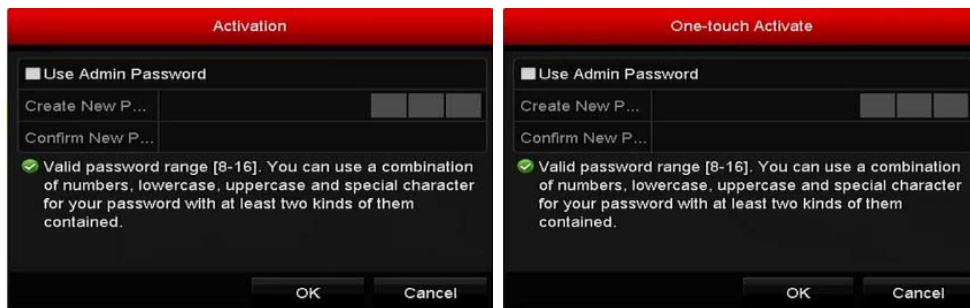

Figure 2. 23 Activate the Camera

3. Set the password of the camera to activate it.

Use Admin Password: when you check the checkbox, the camera (s) will be configured with the same admin password of the operating NVR.



Figure 2. 24 Set New Password

Create New Password: If the admin password is not used, you must create the new password for the camera and confirm it.



STRONG PASSWORD RECOMMENDED– *We highly recommend you create a strong password of your own choosing (using a minimum of 8 characters, including upper case letters, lower case letters, numbers, and special characters) in order to increase the security of your product. And we recommend you reset your password regularly, especially in the high security system, resetting the password monthly or weekly can better protect your product.*

4. Click **OK** to finish the activating of the IP camera. And the security status of camera will be changed to **Active**.

2.6.2 Adding the Online IP Cameras

Purpose:

The main function of the NVR is to connect the network cameras and record the video got from it. So before you can get a live view or record of the video, you should add the network cameras to the connection list of the device.

Before you start:

Ensure the network connection is valid and correct. For detailed checking and configuring of the network, please see *Chapter Checking Network Traffic* and *Chapter Configuring Network Detection*.

Adding the IP Cameras

• **OPTION 1:**

Steps:

1. Click to select an idle window in the live view mode.
2. Click the  icon in the center of the window to pop up the adding IP camera interface.
3. Select the detected IP camera and click the **Add** button to add it directly, and you can click the **Search** button to refresh the online IP camera manually.



Figure 2. 25 Quick Adding IP Camera Interface

Or you can choose to custom add the IP camera by editing the parameters in the corresponding textfiled and then click the **Add** button to add it.

- **OPTION 2:**

1. Select the **Add IP Camera** option from the right-click menu in live view mode or click Menu> Camera> Camera to enter the IP camera management interface.



Figure 2. 26 Adding IP Camera Interface

2. The online cameras with same network segment will be detected and displayed in the camera list.
3. Select the IP camera from the list and click the  button to add the camera. Or you can click the **One-touch Adding** button to add all cameras (with the same login password) from the list.



Make sure the camera to add has already been activated.

4. (For the encoders with multiple channels only) check the **Channel Port** checkbox in the pop-up window, as

shown in the following figure, and click **OK** to add multiple channels.

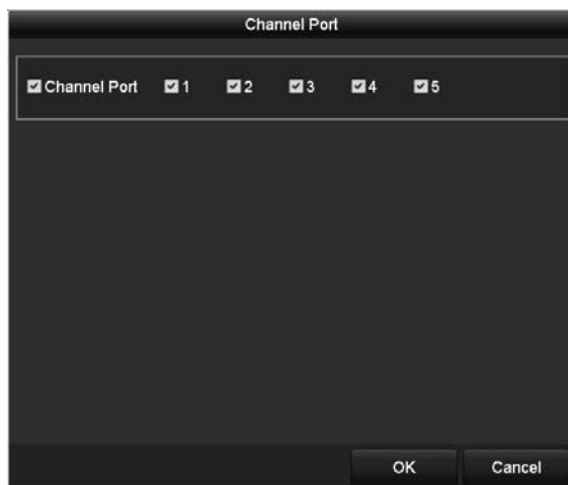

Figure 2. 27 Selecting Multiple Channels

- **OPTION 3:**

Steps:

1. On the IP Camera Management interface, click the **Custom Adding** button to pop up the Add IP Camera (Custom) interface.



Figure 2. 28 Custom Adding IP Camera Interface

2. You can edit the IP address, protocol, management port, and other information of the IP camera to be added.



If the IP camera to add has not been activated, you can activate it from the IP camera list on the camera management interface.

3. (Optional) Check the checkbox of **Continue to Add** to add other IP cameras.
4. Click **Add** to add the camera. The successfully added cameras are listed in the interface.

Refer to the following table for the description of the icons

Table 2. 1 Description of Icons

Icon	Explanation	Icon	Explanation
------	-------------	------	-------------

	Edit basic parameters of the camera		Add the detected IP camera.
	The camera is disconnected; you can click the icon to get the exception information of camera.		Delete the IP camera
	Play the live video of the connected camera.		Advanced settings of the camera.
	Upgrade the connected IP camera.	Security	Show the security status of the camera to be active/inactive or the password strength (strong/medium/weak/risk)



For the added IP cameras, the Security status shows the security level of the password of camera: strong password, weak password and risk password.

Cam...	Add/De...	Status	Security	IP Camera A...	Edit	Upgrade	Camera Name
D1	-		Weak Pass...	10.11.36.38			Camera 01
D2	-		Strong Pas...	10.16.1.250		-	IPdome
D3	-		N/A	192.168.254.4		-	IPCamera 03

Figure 2. 29 Security Level of IP Camera's Password

Enabling the Password of IP Camera Visible

For the admin login user account, you can check the checkbox of **Show Password of IP Camera** to enable the show the passwords of the successfully added IP cameras in the list.

Cam...	Add/De...	Status	Security	IP Camera A...	Edit	Upgra...	Camera Name
D1	-		Weak Pass...	10.11.36.38			Camera 01
D2	-		Strong Pas...	10.16.1.250		-	IPdome
D3	-		N/A	192.168.254.4		-	IPCamera 03
D4	-		N/A	192.168.254.5		-	IPCamera 04
D5	-		N/A	192.168.254.6		-	IPCamera 05
D6	-		N/A	192.168.254.7		-	IPCamera 06
D7	-		N/A	192.168.254.8		-	IPCamera 07
D8	-		N/A	192.168.254.9		-	IPCamera 08
...		-	Active	10.16.1.251		-	-

Refresh One-touch A... Upgrade Delete One-touch A... Custom Addl...

Enable H.265 (For Initial Access)

Net Receive Idle Bandwidth: 75Mbps Back

Figure 2. 30 List of Added IP Cameras

Enabling the H.265 Stream Access

You can check the checkbox of **Enable H.265**, the NVR can automatically switch to the H.265 stream of IP camera (which supports H.265 video format) for the initial access.

2.6.3 Editing the Connected IP Cameras and Configuring Customized Protocols

After the adding of the IP cameras, the basic information of the camera lists in the page, you can configure the basic setting of the IP cameras.

Steps:

1. Click the  icon to edit the parameters; you can edit the IP address, protocol and other parameters.



Figure 2. 31 Edit the Parameters

Channel Port: If the connected device is an encoding device with multiple channels, you can choose the channel to connect by selecting the channel port No. in the dropdown list.

2. Click **OK** to save the settings and exit the editing interface.

To edit advanced parameters:

1. Drag the horizontal scroll bar to the right side and click the  icon.

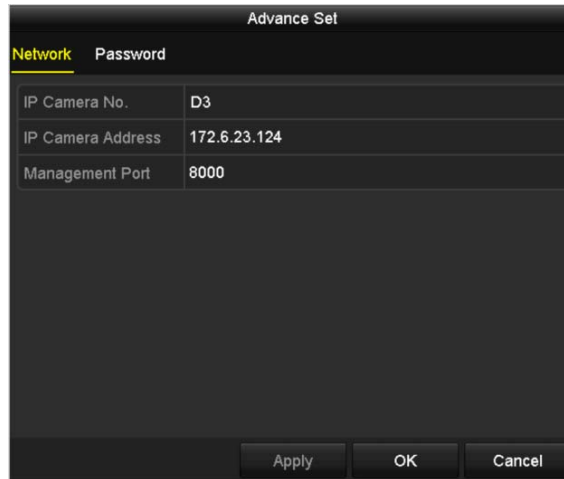

Figure 2. 32 Network Configuration of the Camera

2. You can edit the network information and the password of the camera.



Figure 2. 33 Password Configuration of the Camera

3. Click **OK** to save the settings and exit the interface.

Configuring the customized protocols

Purpose:

To connect the network cameras which are not configured with the standard protocols, you can configure the customized protocols for them.

Steps:

1. Click the **Protocol** button in the custom adding IP camera interface to enter the protocol management interface.

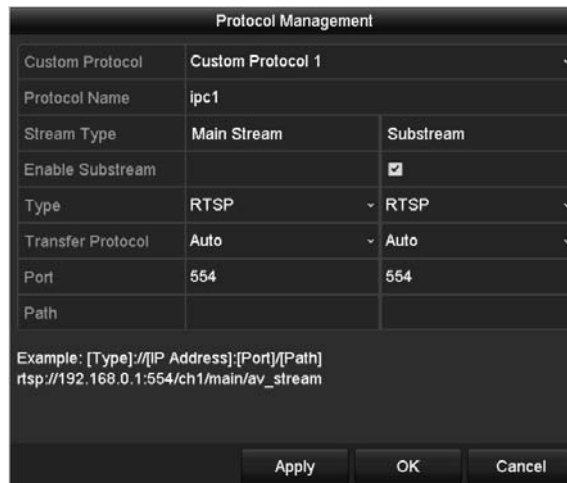

Figure 2. 34 Protocol Management Interface

There are 16 customized protocols provided in the system, you can edit the protocol name; and choose whether to enable the sub-stream.

2. Choose the protocol type of transmission and choose the transfer protocols.



Before customizing the protocol for the network camera, you have to contact the manufacturer of the network camera to consult the URL (uniform resource locator) for getting main stream and sub-stream.

The format of the URL is: [Type]://[IP Address of the network camera]:[Port]/[Path].

Example: rtsp://192.168.1.55:554/ch1/main/av_stream.

- **Protocol Name:** Edit the name for the custom protocol.
- **Enable Substream:** If the network camera does not support sub-stream or the sub-stream is not needed leave the checkbox empty.
- **Type:** The network camera adopting custom protocol must support getting stream through standard RTSP.
- **Transfer Protocol:** Select the transfer protocol for the custom protocol.
- **Port:** Set the port No. for the custom protocol.
- **Path:** Set the resource path for the custom protocol. E.g., ch1/main/av_stream.



The protocol type and the transfer protocols must be supported by the connected network camera.

After adding the customized protocols, you can see the protocol name is listed in the dropdown list, please refer to Figure 2. 35.

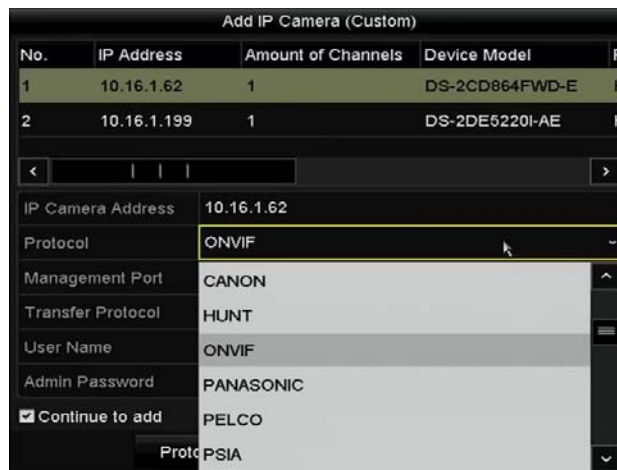

Figure 2. 35 Protocol Setting

3. Choose the protocols you just added to validate the connection of the network camera.

2.6.4 Editing IP Cameras Connected to the PoE Interfaces



This chapter is only applicable for the following models support PoE interface

The PoE interfaces enables the NVR system to pass electrical power safely, along with data, on Ethernet cabling to the connected network cameras.

Example:

For 8ch NVR, if you want to connect 6 network cameras via PoE interfaces and 2 online cameras, you must disable 2 PoE interfaces in the Edit IP Camera menu.

To add Cameras for NVR supporting PoE function:

Before you start:

Connect the network cameras via the PoE interfaces.

Steps:

1. Enter the Camera Management interface.
Menu> Camera> Camera



Figure 2. 36 List of Connected Cameras



The cameras connecting to the PoE interface cannot be deleted in this menu.

2. Click the button, and select the Adding Method in the drop-down list.
 - **Plug-and-Play:** It means that the camera is connected to the PoE interface, so in this case, the parameters of the camera can't be edited. The IP address of the camera can only be edited in the Network Configuration interface.
 - **Manual:** You can disable the PoE interface by selecting the manual while the current channel can be used as a normal channel and the parameters can also be edited.

Input the IP address, the user name and password of administrator manually, and click **OK** to add the IP camera.



Figure 2. 37 Edit IP Camera Interface - Manual

Chapter 3 Live View





3.1 Introduction of Live View

Live view shows you the video image getting from each camera in real time. The NVR automatically enters Live View mode when powered on. It is also at the very top of the menu hierarchy, thus pressing the ESC many times (depending on which menu you're on) brings you to the Live View mode.

Live View Icons

In the live view mode, there are icons at the upper-right of the screen for each channel, showing the status of the record and alarm in the channel, so that you can know whether the channel is recorded, or whether there are alarms occur as soon as possible.

Table 3. 1 Description of Live View Icons

Icons	Description
	Alarm (video loss, video tampering, motion detection, VCA and sensor alarm)
	Record (manual record, schedule record, motion detection, VCA and alarm triggered record)
	Alarm and Record
	Event/Exception (motion detection, VCA, sensor alarm or exception information, appears at the lower-left corner of the screen.

3.2 Operations in Live View Mode

In live view mode, there are many functions provided. The functions are listed below.

- **Single Screen:** showing only one screen on the monitor.
- **Multi-screen:** showing multiple screens on the monitor simultaneously.
- **Auto-switch:** the screen is auto switched to the next one. And you must set the dwell time for each screen on the configuration menu before enabling the auto-switch.
Menu>Configuration>Live View>Dwell Time.
- **Start Recording:** continuous record and motion detection record are supported.
- **Output Mode:** select the output mode to Standard, Bright, Gentle or Vivid.
- **Add IP Camera:** the shortcut to the IP camera management interface.
- **Playback:** playback the recorded videos for current day.
- **Aux Monitor:** When both the HDMI and VGA are connected, the HDMI is used as main output and the VGA is used as the aux output.

When the aux output is enabled, the main output cannot perform any operation, and you can do some basic operation on the live view mode for the Aux output.

3.2.1 Front Panel Operation on Live View

Table 3. 2 Front Panel Operation in Live View

Functions	Front Panel Operation
Common Menu	Quick access to the sub-menus which you frequently visit. Up to 5 sub-menu options are supported.
Menu	Enter the main menu of the system by right clicking the mouse.
Show single screen	Press the corresponding Alphanumeric button. E.g. Press 2 to display only the screen for channel 2.
Show multi-screen	Press the PREV/FOCUS- button.
Manually switch screens	Next screen: right/down direction button. Previous screen: left/up direction button.
Auto-switch	Press Enter button.
Playback	Press Play button.
Switch between main and aux output	Press Main/Aux button.

3.2.2 Using the Mouse in Live View

Table 3. 3 Mouse Operation in Live View

Name	Description
Common Menu	Quick access to the sub-menus which you frequently visit.
Menu	Enter the main menu of the system by right clicking the mouse.

Single Screen	Switch to the single full screen by choosing channel number from the dropdown list.
Multi-screen	Adjust the screen layout by choosing from the dropdown list.
Previous Screen	Switch to the previous screen.
Next Screen	Switch to the next screen.
Start/Stop Auto-switch	Enable/disable the auto-switch of the screens.
Start Recording	Start continuous recording or motion detection recording of all channels.
Add IP Camera	Enter the IP Camera Management interface, and manage the cameras.
Playback	Enter the playback interface and start playing back the video of the selected channel immediately.
PTZ	Enter the PTZ control interface.
Output Mode	Four modes of output supported, including Standard, Bright, Gentle and Vivid.
Aux Monitor	Switch to the auxiliary output mode and the operation for the main output is disabled.



- The *dwel time* of the live view configuration must be set before using **Start Auto-switch**.
- If you enter Aux monitor mode and the Aux monitor is not connected, the mouse operation is disabled; you need to switch back to the Main output with the MAIN/AUX button on the front panel or remote.
- If the corresponding camera supports intelligent function, the Reboot Intelligence option is included when right-clicking mouse on this camera.

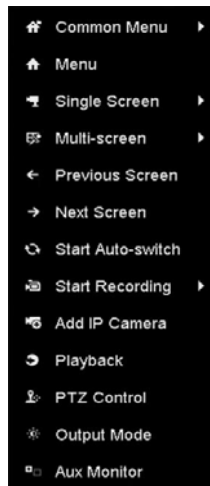

Figure 3. 1 Right-click Menu

3.2.3 Using an Auxiliary Monitor

Certain features of the Live View are also available while in an Aux monitor. These features include:

- **Single Screen:** Switch to a full screen display of the selected camera. Camera can be selected from a dropdown list.

- **Multi-screen:** Switch between different display layout options. Layout options can be selected from a dropdown list.
- **Next Screen:** When displaying less than the maximum number of cameras in Live View, clicking this feature will switch to the next set of displays.
- **Playback:** Enter into Playback mode.
- **PTZ Control:** Enter PTZ Control mode.
- **Main Monitor:** Enter Main operation mode.



In the live view mode of the main output monitor, the menu operation is not available while Aux output mode is enabled.

3.2.4 Quick Setting Toolbar in Live View Mode

On the screen of each channel, there is a quick setting toolbar which shows when you single click the mouse in the corresponding screen.



Figure 3. 2 Quick Setting Toolbar

Table 3. 4 Description of Quick Setting Toolbar Icons

Icon	Description	Icon	Description	Icon	Description
	Enable/Disable Manual Record		Instant Playback		Mute/Audio on
	Capture		PTZ Control		Digital Zoom
	Image Settings		Face Detection		Live View Strategy
	Information		Close		

Instant Playback only shows the record in last five minutes. If no record is found, it means there is no record during the last five minutes.

Digital Zoom is for zooming in the live image. You can zoom in the image to different proportions (1 to 16X) by moving the sliding bar from to . You can also scroll the mouse wheel to control the zoom in/out.



Figure 3. 3 Digital Zoom



Image Settings icon can be selected to enter the Image Settings menu.

You can set the image parameters like brightness, contrast, saturation and hue according to the actual demand.

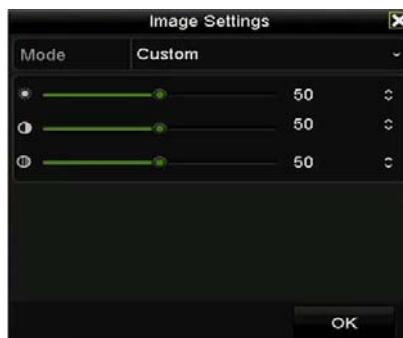

Figure 3. 4 Image Settings- Customize



Live View Strategy can be selected to set strategy, including Real-time, Balanced, Fluency.

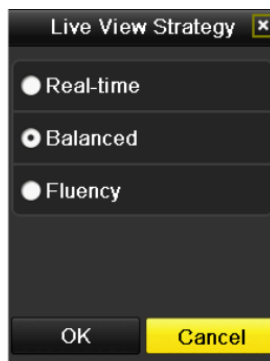

Figure 3. 5 Live View Strategy



Face detection function can be used to detect the human faces in live view mode and save in HDD. When

there are human faces with the specified size detected in the front of the camera, the device will capture the human face and save in HDD.



Move the mouse onto the icon to show the real-time stream information, including the frame rate, bitrate, resolution and stream type.



Figure 3. 6 Information

3.3 Adjusting Live View Settings

Purpose:

Live View settings can be customized according to different needs. You can configure the output interface, dwell time for screen to be shown, mute or turning on the audio, the screen number for each channel, etc.

Steps:

1. Enter the Live View Settings interface.

Menu> Configuration> Live View

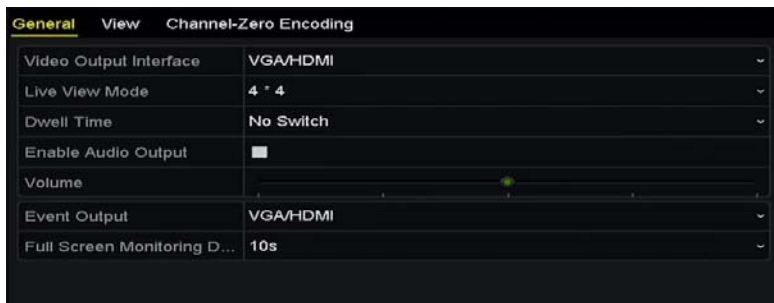

Figure 3. 7 Live View-General

The settings available in this menu include:



- **Video Output Interface:** Designates the output to configure the settings for.
- **Live View Mode:** Designates the display mode to be used for Live View.
- **Dwell Time:** The time in seconds to *dwell* between switching of channels when enabling auto-switch in Live View.
- **Enable Audio Output:** Enables/disables audio output for the selected video output.
- **Volume:** Adjust the volume of live view, playback and two-way audio for the selected output interface.
- **Event Output:** Designates the output to show event video.

- **Full Screen Monitoring Dwell Time:** The time in seconds to show alarm event screen.

2. Setting Cameras Order



Figure 3. 8 Live View- Camera Order

- 1) Select a **View** mode in , including 1/4/6/8/16/25/32/36/64-window division modes are supported depending on different models.
- 2) Select the small window, and double-click on the channel number to display the channel on the window.
You can click  button to start live view for all the channels and click  to stop all the live view.
- 3) Click the **Apply** button to save the setting.

You can also click-and-drag the camera to the desired window on the live view interface to set the camera order.

3.4 Channel-zero Encoding

Purpose:

Sometimes you need to get a remote view of many channels in real time from web browser or CMS (Client Management System) software, in order to decrease the bandwidth requirement without affecting the image quality, channel-zero encoding is supported as an option for you.

Steps:

1. Enter the **Live View** Settings interface.

Menu > Configuration > Live View

2. Select the **Channel-Zero Encoding** tab.

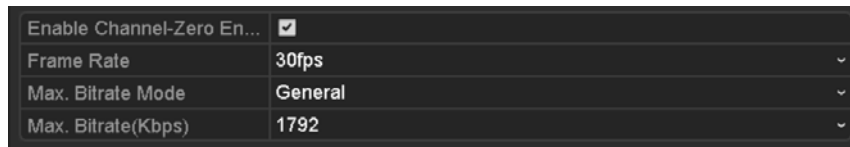

Enable Channel-Zero En...	<input checked="" type="checkbox"/>
Frame Rate	30fps
Max. Bitrate Mode	General
Max. Bitrate(Kbps)	1792

Figure 3. 9 Live View- Channel-Zero Encoding

3. Check the checkbox after **Enable Channel Zero Encoding**.
4. Configure the Frame Rate, Max. Bitrate Mode and Max. Bitrate.

After you set the Channel-Zero encoding, you can get a view in the remote client or web browser of 16 channels in one screen.

Chapter 4 PTZ Controls

4.1 Configuring PTZ Settings

Purpose:

Follow the procedure to set the parameters for PTZ. The configuring of the PTZ parameters should be done before you control the PTZ camera.

Steps:

1. Enter the PTZ Settings interface.

Menu >Camera> PTZ



Figure 4. 1 PTZ Settings

2. Click the **PTZ Parameters** button to set the PTZ parameters.

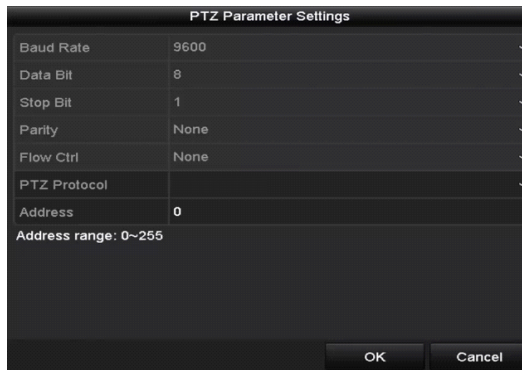

Figure 4. 2 PTZ- General

3. Choose the camera for PTZ setting in the **Camera** dropdown list.
4. Enter the parameters of the PTZ camera.



All the parameters should be exactly the same as the PTZ camera parameters.

5. Click **Apply** button to save the settings.

4.2 Setting PTZ Presets, Patrols & Patterns

Before you start:

Please make sure that the presets, patrols and patterns should be supported by PTZ protocols.

4.2.1 Customizing Presets

Purpose:

Follow the steps to set the Preset location which you want the PTZ camera to point to when an event takes place.

Steps:

1. Enter the PTZ Control interface.

Menu>Camera>PTZ



Figure 4. 3 PTZ Settings

2. Use the directional button to wheel the camera to the location where you want to set preset; and the zoom and focus operations can be recorded in the preset as well.
3. Enter the preset No. (1~255) in the preset text field, and click the **Set** button to link the location to the preset. Repeat the steps2-3 to save more presets.

You can click the **Clear** button to clear the location information of the preset, or click the **Clear All** button to clear the location information of all the presets.

4.2.2 Calling Presets

Purpose:

This feature enables the camera to point to a specified position such as a window when an event takes place.

Steps:



1. Click the button **PTZ** in the lower-right corner of the PTZ setting interface;
Or press the PTZ button on the front panel or click the PTZ Control icon  in the quick setting bar, or select the PTZ option in the right-click menu to show the PTZ control panel.
2. Choose **Camera** in the dropdown list.
3. Click the  button to show the general settings of the PTZ control.



Figure 4. 4 PTZ Panel - General

4. Click to enter the preset No. in the corresponding text field.
5. Click the **Call Preset** button to call it.

4.2.3 Customizing Patrols

Purpose:

Patrols can be set to move the PTZ to different key points and have it stay there for a set duration before moving on to the next key point. The key points are corresponding to the presets. The presets can be set following the steps above in *Customizing Presets*.

Steps:

1. Enter the PTZ Control interface.
Menu>Camera>PTZ



Figure 4. 5 PTZ Settings

2. Select patrol No. in the drop-down list of patrol.
3. Click the **Set** button to add key points for the patrol.



Figure 4. 6 Key point Configuration

4. Configure key point parameters, such as the key point No., duration of staying for one key point and speed of patrol. The key point is corresponding to the preset. The **Key Point No.** determines the order at which the PTZ will follow while cycling through the patrol. The **Duration** refers to the time span to stay at the corresponding key point. The **Speed** defines the speed at which the PTZ will move from one key point to the next.
5. Click the **Add** button to add the next key point to the patrol, or you can click the **OK** button to save the key point to the patrol.
 You can delete all the key points by clicking the **Clear** button for the selected patrol, or click the **Clear All** button to delete all the key pints for all patrols.

4.2.4 Calling Patrols

Purpose:

Calling a patrol makes the PTZ to move according the predefined patrol path.

Steps:



1. Click the button **PTZ** in the lower-right corner of the PTZ setting interface;
 Or press the PTZ button on the front panel or click the PTZ Control icon  in the quick setting bar, or select the PTZ option in the right-click menu to show the PTZ control panel.
2. Click the  button to show the general settings of the PTZ control.



Figure 4. 7 PTZ Panel - General

3. Select a patrol in the dropdown list and click the **Call Patrol** button to call it.

4. You can click the **Stop Patrol** button to stop calling it.

4.2.5 Customizing Patterns

Purpose:

Patterns can be set by recording the movement of the PTZ. You can call the pattern to make the PTZ movement according to the predefined path.

Steps:

1. Enter the PTZ Control interface.
Menu > Camera > PTZ



Figure 4. 8 PTZ Settings

2. Choose pattern number in the dropdown list.
3. Click the **Start** button and click corresponding buttons in the control panel to move the PTZ camera, and click the **Stop** button to stop it.
The movement of the PTZ is recorded as the pattern.

4.2.6 Calling Patterns

Purpose:

Follow the procedure to move the PTZ camera according to the predefined patterns.

Steps:



1. Click the button **PTZ** in the lower-right corner of the PTZ setting interface;
Or press the PTZ button on the front panel or click the PTZ Control icon  in the quick setting bar, or select the PTZ option in the right-click menu to show the PTZ control panel.
2. Click the  button to show the general settings of the PTZ control.



Figure 4.9 PTZ Panel - General

3. Click the **Call Pattern** button to call it.
4. Click the **Stop Pattern** button to stop calling it.

4.2.7 Customizing Linear Scan Limit

Purpose:

The Linear Scan can be enabled to trigger the scan in the horizontal direction in the predefined range.



This function is supported by some certain models.

Steps:

1. Enter the PTZ Control interface.
Menu > Camera > PTZ



Figure 4.10 PTZ Settings

2. Use the directional button to wheel the camera to the location where you want to set the limit, and click the **Left Limit** or **Right Limit** button to link the location to the corresponding limit.



The speed dome starts linear scan from the left limit to the right limit, and you must set the left limit on the left side of the right limit, as well the angle from the left limit to the right limit should be no more than 180°.

4.2.8 Calling Linear Scan



Before operating this function, make sure the connected camera supports the linear scan and is in proper protocol.

Purpose:

Follow the procedure to call the linear scan in the predefined scan range.

Steps:



1. Click the button **PTZ** in the lower-right corner of the PTZ setting interface;
Or press the PTZ button on the front panel or click the PTZ Control icon  in the quick setting bar to enter the PTZ setting menu in live view mode.
2. Click the  button to show the one-touch function of the PTZ control.



Figure 4. 11 PTZ Panel - One-touch

3. Click **Linear Scan** button to start the linear scan and click the Linear Scan button again to stop it.
You can click the **Restore** button to clear the defined left limit and right limit data and the dome needs to reboot to make settings take effect.

4.2.9 One-touch Park



Before operating this function, make sure the connected camera supports the linear scan and is in proper protocol.

Purpose:

For some certain model of the speed dome, it can be configured to start a predefined park action (scan, preset, patrol and etc.) automatically after a period of inactivity (park time).

Steps:

1. Click the button **PTZ** in the lower-right corner of the PTZ setting interface;

Or press the PTZ button on the front panel or click the PTZ Control icon  in the quick setting bar to enter the PTZ setting menu in live view mode.

2. Click the  button to show the one-touch function of the PTZ control.



Figure 4. 12 PTZ Panel - One-touch

3. There are 3 one-touch park types selectable, click the corresponding button to activate the park action.

Park (Quick Patrol): The dome starts patrol from the predefined preset 1 to preset 32 in order after the park time. The undefined preset will be skipped.

Park (Patrol 1): The dome starts move according to the predefined patrol 1 path after the park time.

Park (Preset 1): The dome moves to the predefined preset 1 location after the park time.



The park time can only be set through the speed dome configuration interface, by default the value is 5s.

4. Click the button again to inactivate it.

4.3 PTZ Control Panel

To enter the PTZ control panel, there are two ways supported.

OPTION 1:

In the PTZ settings interface, click the **PTZ** button on the lower-right corner which is next to the Back button.

OPTION 2:

In the Live View mode, you can press the PTZ Control button on the front panel or on the remote control, or choose the PTZ Control icon , or select the PTZ option in the right-click menu.

Click the **Configuration** button on the control panel, and you can enter the PTZ Settings interface.



In PTZ control mode, the PTZ panel will be displayed when a mouse is connected with the device. If no mouse is connected, the **PTZ** icon appears in the lower-left corner of the window, indicating that this camera is in PTZ control mode.



Figure 4.13 PTZ Panel

Table 4.1 Description of the PTZ panel icons

Icon	Description	Icon	Description	Icon	Description
	Direction button and the auto-cycle button		Zoom+, Focus+, Iris+		Zoom-, Focus-, Iris-
	The speed of the PTZ movement		Light on/off		Wiper on/off
	3D-Zoom		Image Centralization		Menu
	Switch to the PTZ control interface		Switch to the one-touch control interface		Switch to the general settings interface
	Previous item		Next item		Start pattern / patrol
	Stop the patrol / pattern movement		Exit		Minimize windows

Chapter 5 Recording Settings

5.1 Configuring Parameters

Purpose:

By configuring the parameters you can define the parameters which affect the image quality, such as the transmission stream type, the resolution and so on.

Before you start:

1. Make sure that the HDD has already been installed. If not, please install a HDD and initialize it.
(Menu>HDD>General)

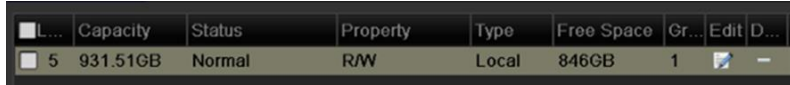

Figure 5. 1 HDD- General

2. Check the storage mode of the HDD
 - 1) Click **Advanced** to check the storage mode of the HDD.
 - 2) If the HDD mode is *Quota*, please set the maximum record capacity and maximum picture capacity.
 - 3) If the HDD mode is **Group**, you should set the HDD group. For detailed information.

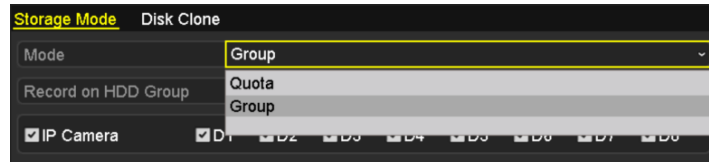

Figure 5. 2 HDD- Advanced

Steps:

1. Enter the Record settings interface to configure the recording parameters:
Menu > Record > Parameters

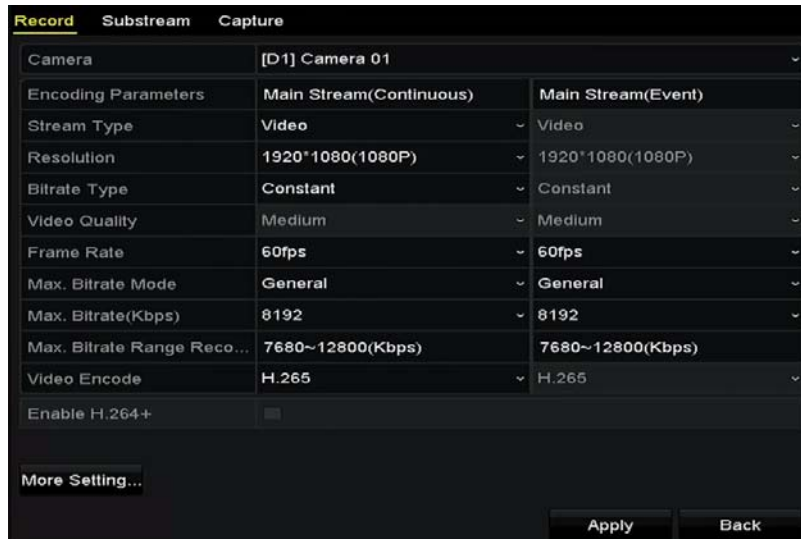

Figure 5. 3 Recording Parameters

2. Parameters Setting for Recording

- 1) Select **Record** tab page to configure. You can configure the stream type, the resolution, and other parameters on your demand.
 - **Video Encode:** select the video encoding to H.265 or H.264.
 - **Enable H.264+ Mode:** check the checkbox to enable. Once enabled, the **Max. Bitrate Mode**, **Max. Bitrate(Kbps)** and **Max. Bitrate Range Recommend** are not configurable. Enabling it helps to ensure the high video quality with a lowered bitrate.



The H.265 and H.264+ should be supported by the connected IP camera.

- 2) Click the **More Settings** button to set the advanced parameters for recording and then click **OK** button to finish editing.



Figure 5. 4 More Settings

- **Pre-record:** The time you set to record before the scheduled time or event. For example, when an alarm triggers the recording at 10:00, and if you set the pre-record time as 5 seconds, the camera records at 9:59:55.
- **Post-record:** The time you set to record after the event or the scheduled time. For example, when an alarm triggered recording ends at 11:00, and if you set the post-record time as 5 seconds, it records till 11:00:05.
- **Expired Time:** The expired time is period for a recorded file to be kept in the HDD. When the deadline is reached, the file will be deleted. If you set the expired time to 0, the file will not be deleted. The actual keeping time for the file should be determined by the capacity of the HDD.
- **Redundant Record:** By enabling redundant record you save the record in the redundant HDD.
- **Record Audio:** Check the checkbox to enable or disable audio recording.
- **Video Stream:** Main stream and sub-stream are selectable for recording. When you select sub-stream, you can record for a longer time with the same storage space.

- 3) Click **Apply** to save the settings.



You can enable the ANR (Automatic Network Replenishment) function via the web browser (Configuration > Storage > Schedule Settings > Advanced) to save the video files in the IP camera when the network is disconnected, and synchronize the files to the NVR when the network is resumed.



- The redundant record/capture is used when you want to save the record files in the redundant HDD. You must configure the redundant HDD in HDD settings..
- The parameters of Main Stream (Event) are read-only.

3. Parameters Settings for Sub-stream

- 1) Enter the Sub-stream tab page.

Record	Substream	Capture
Camera	[D1] Camera 01	
Stream Type	Video	
Resolution (max.: 720P)	704*480(4CIF)	
Bitrate Type	Variable	
Video Quality	Medium	
Frame Rate	Full Frame	
Max. Bitrate Mode	General	
Max. Bitrate (Kbps) (max....)	1024	
Max. Bitrate Range Reco...	1152~1920(Kbps)	
Video Encode	H.265	

Figure 5. 5 Sub-stream Parameters

- 2) Configure the parameters of the camera.
- 3) Click **Apply** to save the settings.



The interval is the time period between two capturing actions. You can configure all the parameters on this menu on your demand.

5.2 Configuring Recording Schedule

Purpose:

Set the record schedule, and then the camera automatically starts/stops recording according to the configured schedule.



In this chapter, we take the record schedule procedure as an example, and the same procedure can be applied to configure schedule recording.

Steps:

1. Enter the Record Schedule interface.
Menu>Record >Schedule
2. Configure Record Schedule
 - 1) Select Record Schedule.

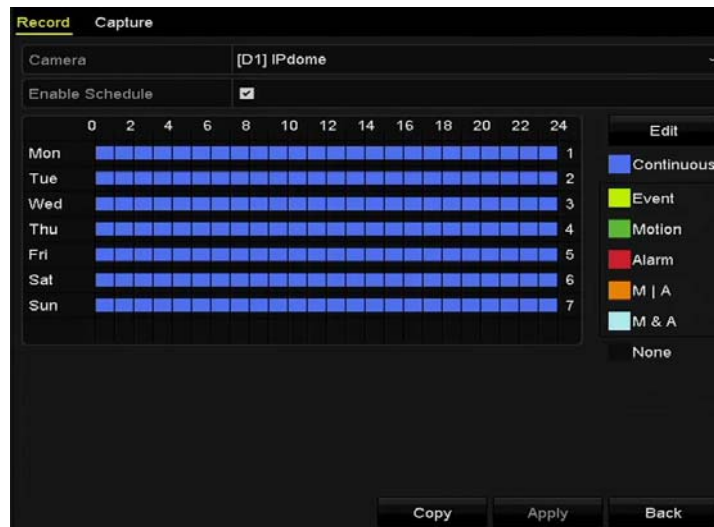

Figure 5. 6 Record Schedule

Different recording types are marked in different color icons.

Continuous: scheduled recording.

Event: recording triggered by all event triggered alarm.

Motion: recording triggered by motion detection.

Alarm: recording triggered by alarm.

M/A: recording triggered by either motion detection or alarm.

M&A: recording triggered by motion detection and alarm.



You can delete the set schedule by clicking the **None** icon.

- 2) Choose the camera you want to configure.
- 3) Select the check box after the **Enable Schedule** item.
- 4) Click **Edit** button or click on the color icon under the edit button and draw the schedule line on the panel.

Edit the schedule:

I. In the message box, you can choose the day to which you want to set schedule.

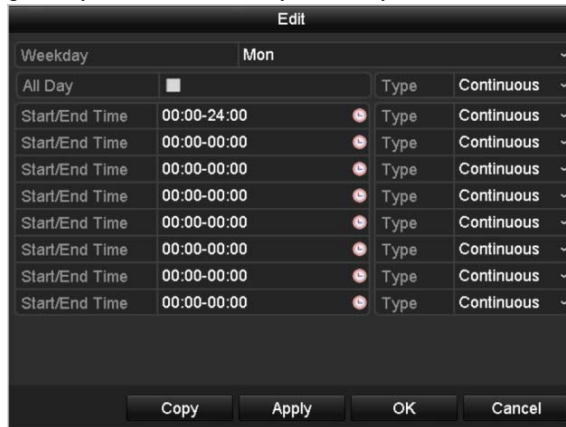



Figure 5. 7 Recording Schedule Interface

You can click the  button to set the accurate time of the schedule.

II. To schedule an all-day recording, check the checkbox after the **All Day** item.

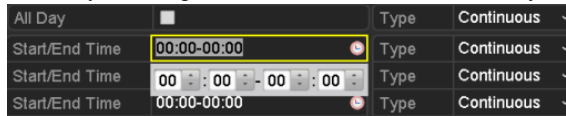

Figure 5. 8 Edit Schedule

III. To arrange other schedule, set the Start/End time for each period.



Up to 8 periods can be configured for each day. And the time periods can't be overlapped each other.

IV. Select the record type in the dropdown list.



- To enable Motion, Alarm, M | A (motion or alarm), M & A (motion and alarm) and VCA (Video Content Analysis) triggered recording, you must configure the motion detection settings, alarm input settings or VCA settings as well.
- The VCA settings are only available to the smart IP cameras.

Repeat the above edit schedule steps to schedule recording for other days in the week. If the schedule can also be applied to other days, click **Copy**.



Figure 5. 9 Copy Schedule to Other Days

- V. Click **OK** to save setting and back to upper level menu.
- VI. Click **Apply** in the Record Schedule interface to save the settings.

Draw the schedule:

- I. Click on the color icons, you can choose the schedule type as continuous or event.



Figure 5. 10 Draw the Schedule

- II. Click the **Apply** button to validate the settings.
3. (Optional) If the settings can also be used to other channels, click **Copy**, and then choose the channel to which you want to copy.
 4. Click **Apply** to save the settings.



Figure 5. 11 Copy Schedule to Other Channels

5.3 Configuring Motion Detection Recording

Purpose:

Follow the steps to set the motion detection parameters. In the live view mode, once a motion detection event takes place, the NVR can analyze it and do many actions to handle it. Enabling motion detection function can trigger certain channels to start recording, or trigger full screen monitoring, audio warning, notify the surveillance center and so on. In this chapter, you can follow the steps to schedule a record which triggered by the detected motion.

Steps:

1. Enter the Motion Detection interface.

Menu>Camera>Motion

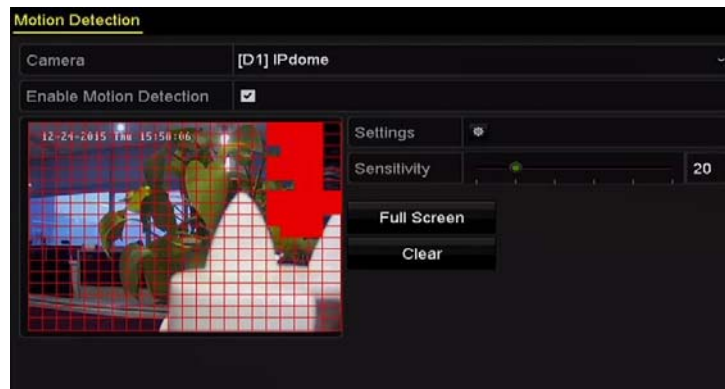

Figure 5.12 Motion Detection

2. Configure Motion Detection:

- 1) Choose camera you want to configure.
- 2) Check the checkbox after **Enable Motion Detection**.
- 3) Drag and draw the area for motion detection by mouse. If you want to set the motion detection for all the area shot by the camera, click **Full Screen**. To clear the motion detection area, click **Clear**.
- 4) Click **Settings**, and the message box for channel information pops up.



Figure 5.13 Motion Detection Handling

- 5) Select the channels which you want the motion detection event to trigger recording.
 - 6) Click **Apply** to save the settings.
 - 7) Click **OK** to back to the upper level menu.
 - 8) Exit the Motion Detection menu.
3. Edit the Motion Detection Record Schedule

5.4 Configuring Alarm Triggered Recording

Purpose:

Follow the procedure to configure alarm triggered recording.

Steps:

1. Enter the Alarm settings interface.

Menu> Configuration> Alarm

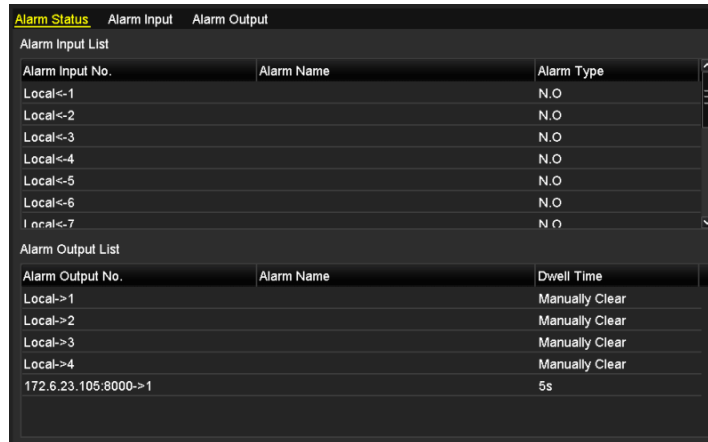

Figure 5. 14 Alarm Settings

2. Click **Alarm Input**.



Figure 5. 15 Alarm Settings- Alarm Input

- 1) Select Alarm Input number and configure alarm parameters.
- 2) Choose N.O (normally open) or N.C (normally closed) for alarm type.
- 3) Check the checkbox for Setting .
- 4) Click **Settings**.

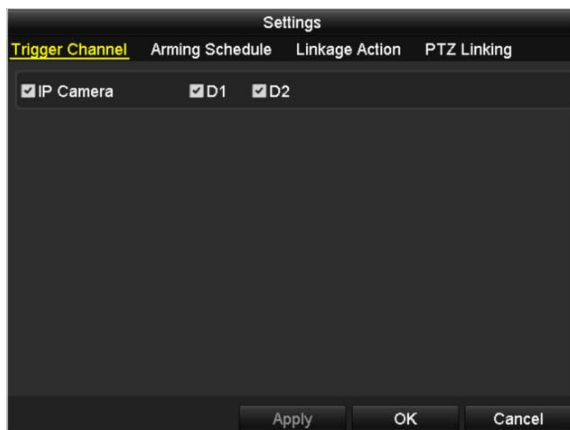

Figure 5. 16 Alarm Settings

- 5) Choose the alarm triggered recording channel.
- 6) Check the checkbox to select channel.
- 7) Click **Apply** to save settings.
- 8) Click **OK** to back to the upper level menu.

Repeat the above steps to configure other alarm input parameters.

If the settings can also be applied to other alarm inputs, click **Copy** and choose the alarm input number.

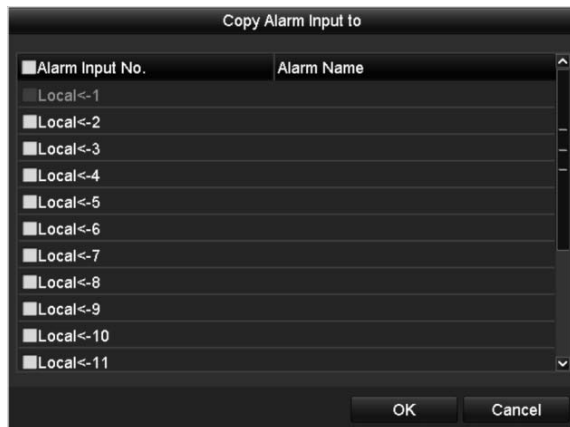

Figure 5. 17 Copy Alarm Input

3. Edit the Alarm triggered record in the Record Schedule setting interface.

5.5 Manual Recording

Purpose:

Follow the steps to set parameters for the manual recording. Using manual recording, you need to manually cancel the record. The manual recording is prior to the scheduled recording.

Steps:

1. Enter the Manual settings interface.

Menu> Manual

Or press the **REC/SHOT** button on the front panel.

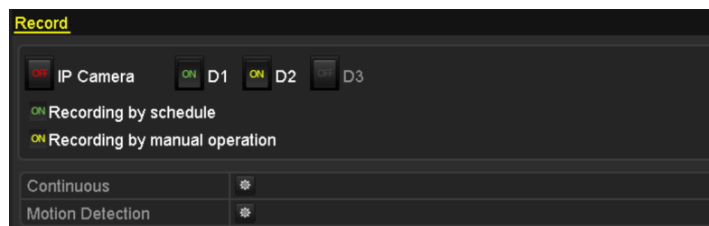

Figure 5. 18 Manual Record

2. Enable the Manual Recording.

1) Select **Record** on the left bar.

2) Click the status button before camera number to change **OFF** to **ON**.

3. Disable manual record.

Click the status button to change **ON** to **OFF**.



Green icon **ON** means that the channel is configured the record schedule. After rebooting, all the manual records enabled will be canceled.

5.6 Configuring Holiday Recording

Purpose:

Follow the steps to configure the record schedule on holiday for that year. You may want to have different plan for recording on holiday.

Steps:

1. Enter the Record setting interface.

Menu > Record > Holiday

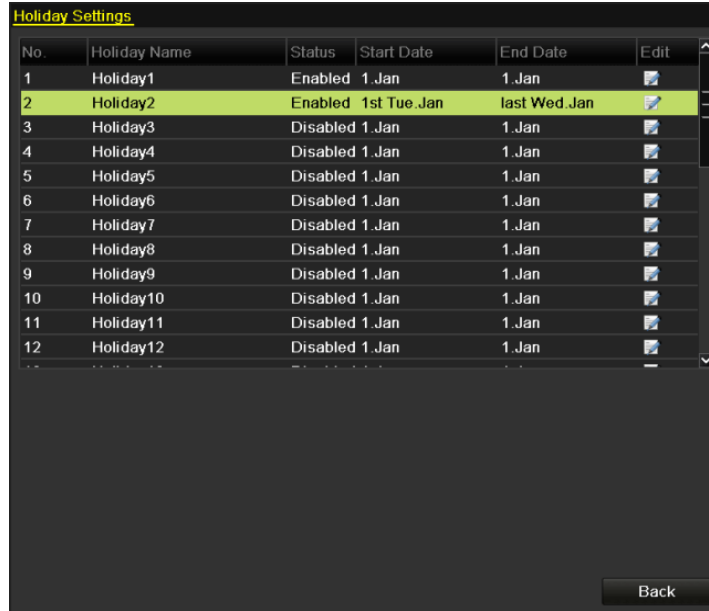

Figure 5. 19 Holiday Settings

2. Enable Edit Holiday schedule.

- 1) Click to enter the Edit interface.

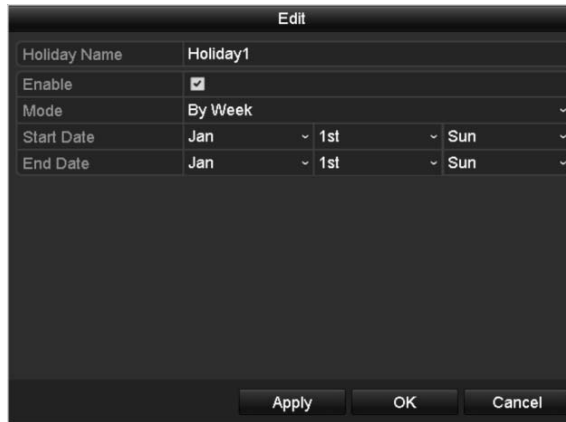

Figure 5. 20 Edit Holiday Settings

- 2) Check the checkbox after **Enable Holiday**.
- 3) Select Mode from the dropdown list.

There are three different modes for the date format to configure holiday schedule.

- 4) Set the start and end date.
 - 5) Click **Apply** to save settings.
 - 6) Click **OK** to exit the Edit interface.
3. Enter Record Schedule settings interface to edit the holiday recording schedule.

5.7 Configuring Redundant Recording

Purpose:

Enabling redundant recording, which means saving the record files not only in the R/W HDD but also in the redundant HDD, will effectively enhance the data safety and reliability. .

Steps:

1. Enter HDD Information interface.

Menu> HDD

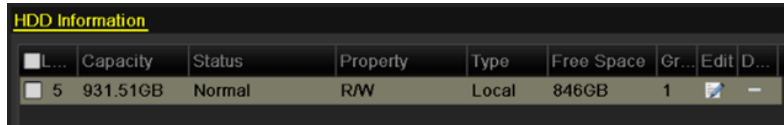



Figure 5. 21 HDD General

2. Select the **HDD** and click  to enter the Local HDD Settings interface.

- 1) Set the HDD property to Redundancy.

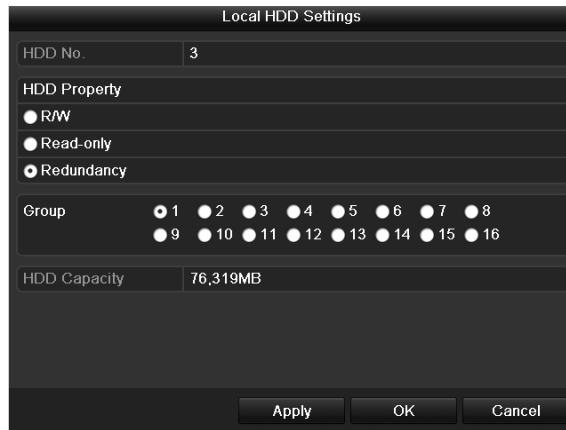

Figure 5. 22 HDD General-Editing

- 2) Click **Apply** to save the settings.
- 3) Click **OK** to back to the upper level menu.



You must set the Storage mode in the HDD advanced settings to Group before you set the HDD property to Redundant. For detailed information, please refer to *Chapter 11.4.1 Setting HDD Property*. There should be at least another HDD which is in Read/Write status.

3. Enter the Record setting interface.

Menu> Record> Parameters

- 1) Select **Record** tab.
- 2) Click **More Settings** to enter the following interface.



Figure 5. 23 Record Parameters

- 3) Select Camera you want to configure in the drop-down list.
- 4) Check the checkbox of **Redundant Record**
- 5) Click **OK** to save settings and back to the upper level menu.

Repeat the above steps for configuring other channels.

5.8 Configuring HDD Group for Recording

Purpose:

You can group the HDDs and save the record files in certain HDD group.

Steps:

1. Enter HDD setting interface.

Menu>HDD

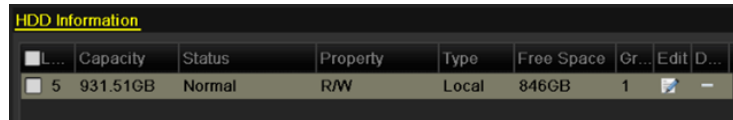



Figure 5. 24 HDD General

2. Select **Advanced** on the left side menu.



Figure 5. 25 Storage Mode

Check whether the storage mode of the HDD is Group. If not, set it to Group.

3. Select **General** in the left side menu
4. Click  to enter editing interface.
5. Configuring HDD group.
 - 1) Choose a group number for the HDD group.
 - 2) Click **Apply** and then in the pop-up message box, click **Yes** to save your settings.
 - 3) Click **OK** to back to the upper level menu.

Repeat the above steps to configure more HDD groups.
6. Choose the Channels which you want to save the record files in the HDD group.
 - 1) Select **Advanced** on the left bar.
 - 2) Choose Group number in the dropdown list of **Record on HDD Group**
 - 3) Check the channels you want to save in this group.
 - 4) Click **Apply** to save settings.



After having configured the HDD groups, you can configure the Recording settings following the procedure provided in *Chapter 5.2-5.7*.

5.9 Files Protection

Purpose:

You can lock the recording files or set the HDD property to Read-only to protect the record files from being overwritten.

5.9.1 Locking the Recording Files

Lock File when Playback

Steps:

1. Enter Playback interface.
Menu> Playback
2. Check the checkbox of channel(s) in the channel list and then double-click to select a date on the calendar.



Figure 5. 26 Normal Playback

3. During playback, click the  button to lock the current recording file.



In the multi-channel playback mode, clicking the  button will lock all the record files related to the playback channels.

4. You can click the  button to pop up the file management interface. Click the **Locked File** tab to check and export the locked files.



Figure 5. 27 Locked File Management

In the File Management interface, you can also click to change it to to unlock the file and the file is not protected.

● **Lock File when Export**

Steps:

1. Enter Export setting interface.

Menu> Export

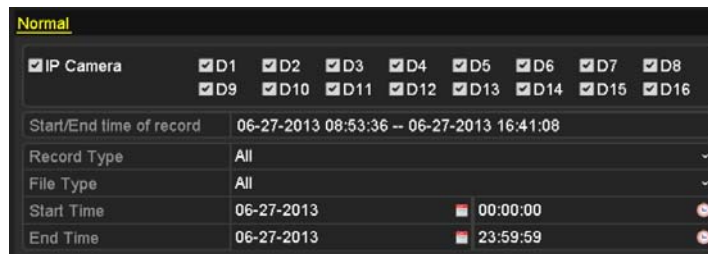



Figure 5. 28 Export

2. Select the channels you want to search by checking the checkbox to .
3. Configure the record type, file type start/end time.
4. Click **Search** to show the results.



Figure 5. 29 Export- Search Result

5. Protect the record files.

- 1) Find the record files you want to protect, and then click the  icon which will turn to , indicating that the file is locked.



The record files of which the recording is still not completed cannot be locked.



- 2) Click  to change it to  to unlock the file and the file is not protected.



Figure 5.30 Unlocking Attention

5.9.2 Setting HDD Property to Read-only

Steps:

1. Enter HDD setting interface.

Menu> HDD

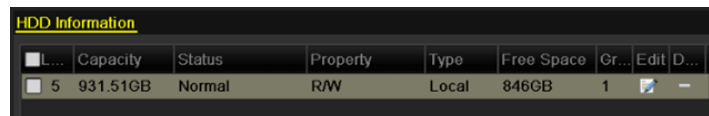

Figure 5.31 HDD General

2. Click  to edit the HDD you want to protect.



Figure 5.32 HDD General- Editing



To edit HDD property, you need to set the storage mode of the HDD to Group. See *Chapter Managing HDD Group*.

3. Set the HDD property to Read-only.
4. Click **OK** to save settings and back to the upper level menu.



- You cannot save any files in a Read-only HDD. If you want to save files in the HDD, change the property to R/W.
- If there is only one HDD and is set to Read-only, the NVR can't record any files. Only live view mode is available.
- If you set the HDD to Read-only when the NVR is saving files in it, then the file will be saved in next R/W HDD. If there is only one HDD, the recording will be stopped.

Chapter 6 Playback

6.1 Playing Back Record Files

6.1.1 Instant Playback

Purpose:

Play back the recorded video files of a specific channel in the live view mode. Channel switch is supported.

Instant playback by channel

Steps:

Choose a channel in live view mode and click the  button in the quick setting toolbar.



In the instant playback mode, only record files recorded during the last five minutes on this channel will be played back.



Figure 6. 1 Instant Playback Interface

6.1.2 Playing Back by Normal Search

Playback by Channel

Enter the Playback interface.

right click a channel in live view mode and select Playback from the menu, as shown in Figure 6. 2.

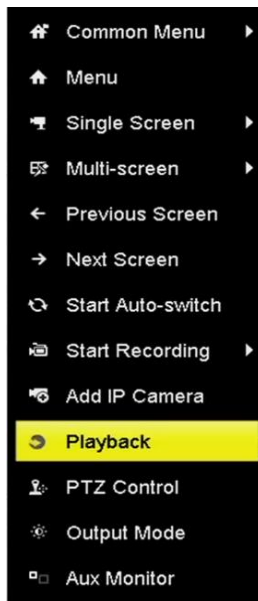

Figure 6. 2 Right-click Menu under Live View



Pressing numerical buttons will switch playback to the corresponding channels during playback process.

Playback by Time

Purpose:

Play back video files recorded in specified time duration. Multi-channel simultaneous playback and channel switch are supported.

Steps:

1. Enter playback interface.
Menu>Playback
2. Check the checkbox of channel(s) in the channel list and then double-click to select a date on the calendar.



Figure 6. 3 Playback Calendar



If there are record files for that camera in that day, in the calendar, the icon for that day is displayed as .

Otherwise it is displayed as 18

Playback Interface

You can use the toolbar in the bottom part of Playback interface to control playing progress, as shown in Figure 6.4.



Figure 6.4 Playback Interface

Click the channel(s) to execute simultaneous playback of multiple channels.



Figure 6.5 Toolbar of Playback



- The 03-22-2016 17:24:02 -- 01-18-2016 11:36:12 indicates the start/end time of the recorded video files.
- The indicates the smart playback time bar and the indicates the normal playback time bar.
- Playback progress bar: use the mouse to click any point of the progress bar or drag the progress bar to locate specific frames.

Table 6.1 Detailed Explanation of Playback Toolbar

Item	Button	Operation	Button	Operation
Smart Search		Set full screen for motion detection		Draw line for the line crossing detection
		Draw quadrilateral for the intrusion detection		Filter video files by setting the target characters
Operations		Audio on/Mute		Start/Stop clipping
		Capture Picture		Lock File

		Add default tag		Add customized tag
		File management for video clips , locked files and tags		Digital Zoom
Playing Control		Pause/Play		Reverse play/ Pause
		Slow forward		Stop
		30s forward		30s reverse
		Next day		Fast forward
		Previous day		
Time Bar Scaling		Previous/Next period		Play the time bar in 30 minutes (default)
		Play the time bar in 1 hour		Play the time bar in 2 hours
		Play the time bar in 6 hours		Play the time bar in 24 hours
Fisheye Expansion		180° panorama		360° panorama
		PTZ expansion		Fisheye



The playing speed of 256X is supported.

6.1.3 Playing back by Smart Playback

Purpose:

The smart playback function provides an easy way to get through the less effective information. When you select the smart playback mode, the system will analyze the video containing the motion or VCA information, mark it with green color and play it in the normal speed while the video without motion will be played in the 16-time speed. The smart playback rules and areas are configurable.

Before you start:

To get the smart search result, the corresponding event type must be enabled and configured on the IP camera. Here we take the intrusion detection as an example.

1. Log in the IP camera by the web browser, and enable the intrusion detection by checking the checkbox of it. You may enter the motion detection configuration interface by Configuration> Advanced Configuration> Events> Intrusion Detection.

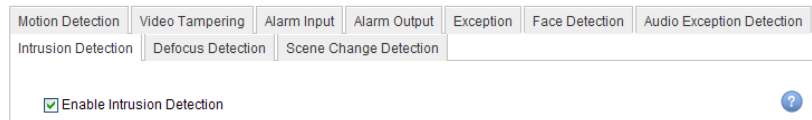

Figure 6. 6 Setting Intrusion Detection on IP Camera

2. Configure the required parameters of intrusion detection, including area, arming schedule and linkage methods. Refer to the user manual of smart IP camera for detailed instructions.

Steps:



1. Enter Playback interface.
Menu>Playback
2. Select the **Normal** in the drop-down list on the top-left side.
3. Select a camera in the camera list.
4. Select a date in the calendar and click the  button on the left toolbar to play the video file.



Figure 6. 7 Playback by Smart Search

5. Click the  status bar to switch to the playback by smart search interface.
6. Set the rules and areas for smart search of line crossing detection, intrusion detection or motion detection event triggered recording.

Full Screen Motion/Intrusion Detection

Click the  to set the full-screen full screen as the detection area.

- **Line Crossing Detection**

Select the  button, and click on the image to specify the start point and end point of the line.



- **Intrusion Detection**

Click the  button, and specify 4 points to set a quadrilateral region for intrusion detection. Only one region can be set.

- **Motion Detection**

Click the  button and then click and draw the mouse to set the detection area manually. You can also

click the  button to set the full screen as the detection area.

7. Click  to search and play the matched video files.
8. (Optional) You can click  to filter the searched video files by setting the target characters, including the

gender and age of the human and whether he/she wears glasses.



Figure 6. 8 Set Result Filter

6.1.4 Playing Back by Event Search

Purpose:

Play back record files on one or several channels searched out by event type (e.g., alarm input, motion detection and VCA).

Steps:

1. Enter the Playback interface.
Menu>Playback
2. Select the **Event** in the drop-down list on the top-left side.
3. Select the major type to **Alarm Input**, **Motion** or **VCA** as the event type.



We take playback by VCA as the example in the following instructions.

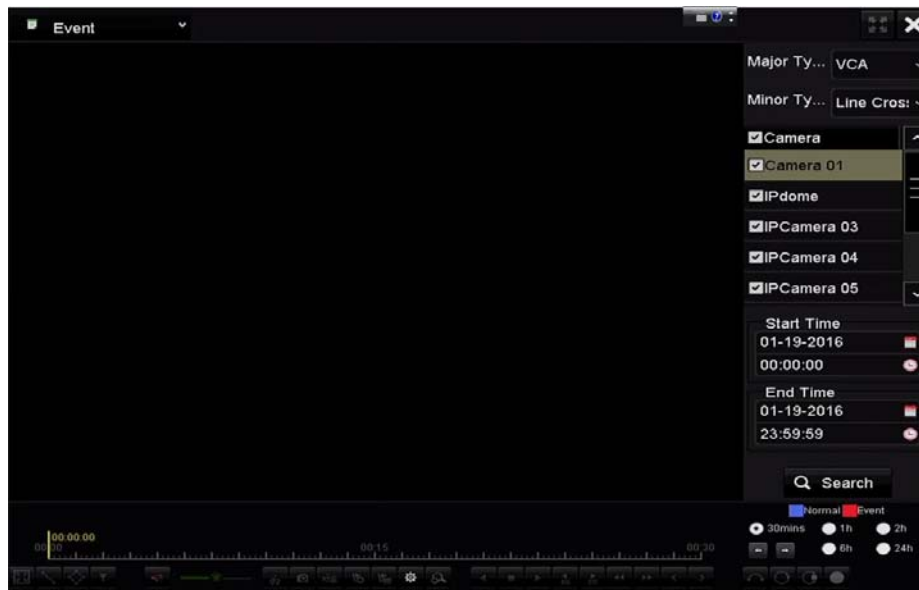

Figure 6. 9 Event Search Interface

4. Select the minor type of VCA from the drop-down list.
5. Select the camera (s) for searching, and set the Start time and End time.
6. Click **Search** button to get the search result information. You may refer to the right-side bar for the result.
7. Select a result item and click button to play back the file.



Pre-play and post-play can be configured.

8. Enter the Synch Playback interface to select the camera (s) for synchronous playback.



Figure 6. 10 Synch Playback Interface

9. Enter the playback interface.

The toolbar in the bottom part of playback interface can be used to control playing process.

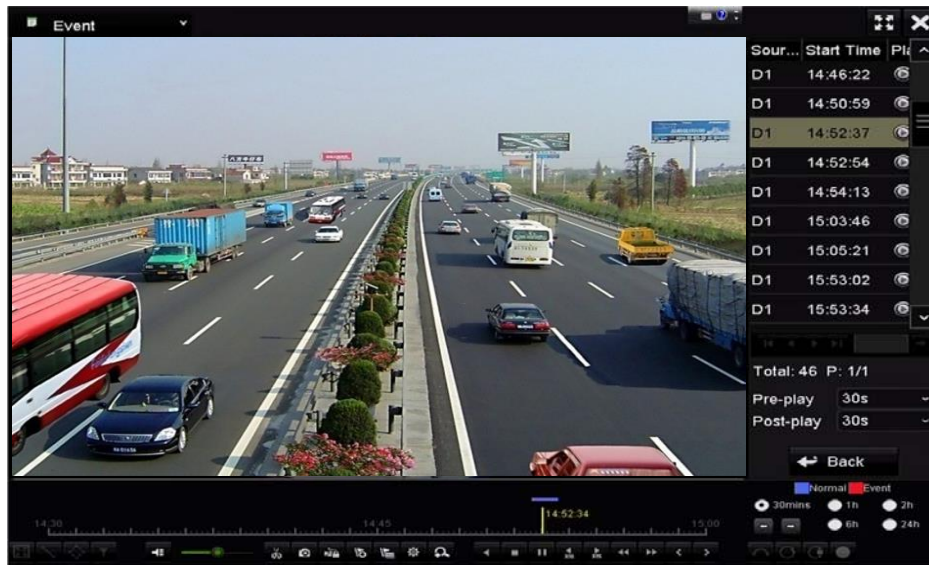



Figure 6. 11 Interface of Playback by Event

You can click  or  button to select the previous or next event. Please refer to Table 6.1 for the description of buttons on the toolbar.

6.1.5 Playing Back by Tag

Purpose:

Video tag allows you to record related information like people and location of a certain time point during playback. You can use video tag(s) to search for record files and position time point.

Before playing back by tag:

1. Enter Playback interface.
Menu>Playback
2. Search and play back the record file(s).



Figure 6. 12 Interface of Playback by Time

Click button to add default tag.

Click button to add customized tag and input tag name.



Max. 64 tags can be added to a single video file.

3. Tag management.

Click button to enter the File Management interface and click **Tag** to manage the tags. You can check, edit, and delete tag(s).



Figure 6. 13 Tag Management Interface

Playing back by Tag

Steps:

1. Select the **Tag** from the drop-down list in the Playback interface.
2. Choose channels, edit start time and end time, and then click **Search** to enter Search Result interface.



Figure 6. 14 Interface of Playback by Tag



You can enter keyword in the textbox to search the tag on your command.

3. Click button to play back the selected tag file.
You can click the **Back** button to back to the search interface.



Figure 6. 15 Interface of Playback by Tag



Pre-play and post-play can be configured.

You can click or button to select the previous or next tag. Please refer to Table 6.1 for the description of buttons on the toolbar.

6.1.6 Playing Back by Sub-periods

Purpose:

The video files can be played in multiple sub-periods simultaneously on the screens.

Steps:

1. Enter Playback interface.
Menu>Playback
2. Select **Sub-periods** from the drop-down list in the upper-left corner of the page to enter the Sub-periods Playback interface.
3. Select a date and start playing the video file.
4. Select the Split-screen Number from the dropdown list. Up to 16 screens are configurable.



Figure 6. 16 Interface of Sub-periods Playback



According to the defined number of split-screens, the video files on the selected date can be divided into average segments for playback. E.g., if there are video files existing between 16:00 and 22:00, and the 6-screen display mode is selected, then it can play the video files for 1 hour on each screen simultaneously.

6.1.7 Playing Back by System Logs

Purpose:

Play back record file(s) associated with channels after searching system logs.

Steps:

1. Enter Log Information interface.
Menu>Maintenance>Log Information

2. Click **Log Search** tab to enter Playback by System Logs.

Set search time and type and click **Search** button.

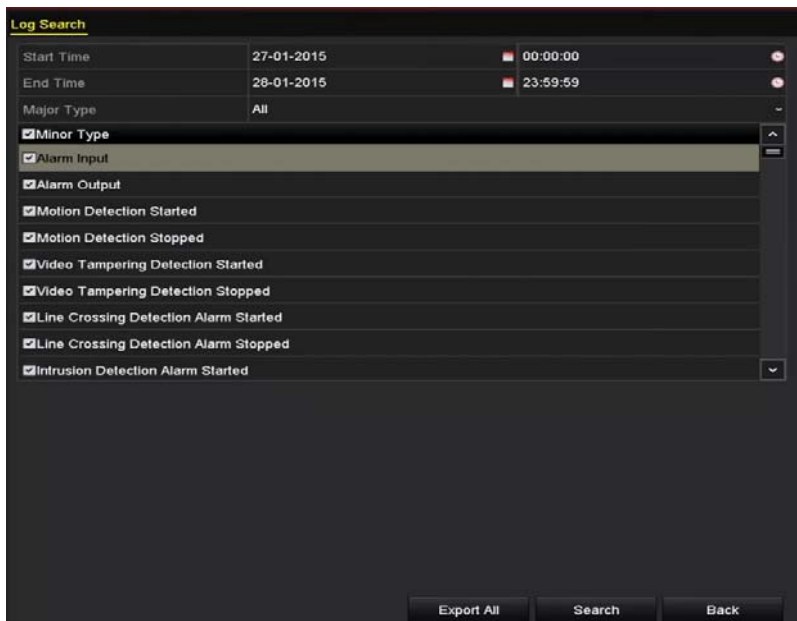





Figure 6. 17 System Log Search Interface

3. Choose a log with record file and click  button to enter Playback interface.



If there is no record file at the time point of the log, the message box “No result found” will pop up.

Search Result						
No.	Major Type	Time	Minor Type	Parameter	Play	Details
1	Exception	27-01-2015 10:02:58	HDD Error	N/A	—	✓
2	Exception	27-01-2015 10:02:58	HDD Error	N/A	—	✓
3	Exception	27-01-2015 10:02:58	HDD Error	N/A	—	✓
4	Operation	27-01-2015 10:03:00	Abnormal Shutd...	N/A	—	✓
5	Operation	27-01-2015 10:03:01	Power On	N/A	—	✓
6	Exception	27-01-2015 10:03:13	Record/Capture ...	N/A		✓
7	Exception	27-01-2015 10:03:13	Record/Capture ...	N/A		✓
8	Exception	27-01-2015 10:03:13	Record/Capture ...	N/A		✓
9	Operation	27-01-2015 11:06:34	Local Operation:...	N/A	—	✓
10	Exception	27-01-2015 11:07:36	HDD Error	N/A	—	✓

Total: 417 P: 1/5

Figure 6. 18 Result of System Log Search

4. Playback interface.

The toolbar in the bottom part of Playback interface can be used to control playing process.







Figure 6. 19 Interface of Playback by Log

6.1.8 Playing Back External File

Purpose:

Perform the following steps to look up and play back files in the external devices.

Steps:

1. Enter Tag Search interface.
Menu>Playback
2. Select the **External File** in the drop-down list on the top-left side.
The files are listed in the right-side list.
You can click the  button to refresh the file list.
3. Select and click the  button to play back it. And you can adjust the playback speed by clicking  and .

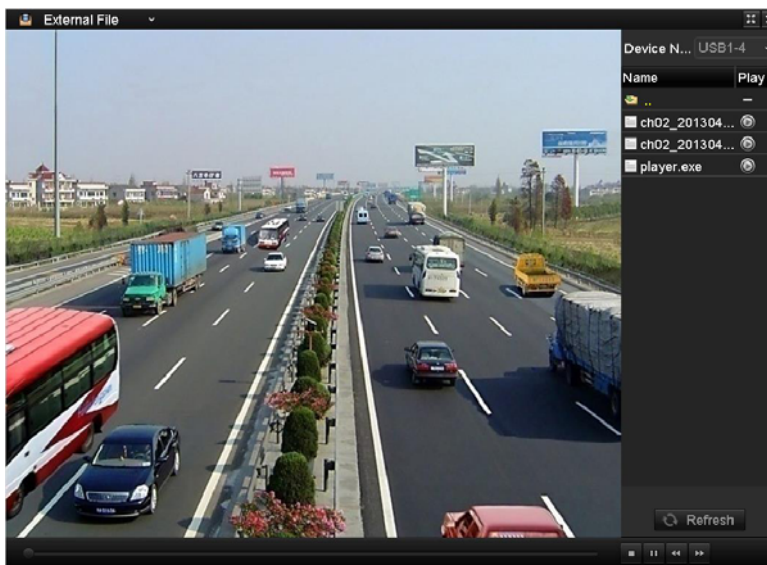

Figure 6. 20 Interface of External File Playback

6.2 Auxiliary Functions of Playback

6.2.1 Playing Back Frame by Frame

Purpose:



Play video files frame by frame, in case of checking image details of the video when abnormal events happen.

Steps:



- **Using a Mouse:**

Go to Playback interface.

If you choose playback of the record file: click button  until the speed changes to Single frame and one click on the playback screen represents playback of one frame.

If you choose reverse playback of the record file: click button  until the speed changes to Single frame and one click on the playback screen represents reverse playback of one frame. It is also feasible to use button  in toolbar.

- **Using the Front Panel:**

Click the  button to set the speed to Single frame. One click on  button, one click on the playback screen or Enter button on the front panel represents playback or reverse playback of one frame.

6.2.2 Thumbnails View

With the thumbnails view on the playback interface, you can conveniently locate the required video files on the time bar.

Steps:

1. Enter the playback interface and start to play the video files.



Figure 6. 21 Thumbnails View

2. Move the mouse to the time bar to get the preview thumbnails of the video files. Select and double click on a required thumbnail to enter the full-screen playback.



The thumbnail view is supported only in the 1X single-camera playback mode.

6.2.3 Fast View

You can hold the mouse to drag on the time bar to get the fast view of the video files.

Steps:

1. Enter the playback interface and start to play the video files.



Figure 6.22 Playback Interface

2. Use the mouse to hold and drag through the playing time bar to fast view the video files.
3. Release the mouse to the required time point to enter the full-screen playback.



The fast view is supported only in the 1X single-camera playback mode.

6.2.4 Digital Zoom

Steps:

1. Click the button on the playback control bar to enter Digital Zoom interface.
2. You can zoom in the image to different proportions (1 to 16X) by moving the sliding bar from to . You can also scroll the mouse wheel to control the zoom in/out.



Figure 6.23 Draw Area for Digital Zoom

3. Right-click the image to exit the digital zoom interface.

6.2.5 File Management

You can manage the video clips, locked files and tags you have added in the playback mode.

Steps:

1. Enter the playback interface.
2. Click  on the toolbar to enter the file management interface.

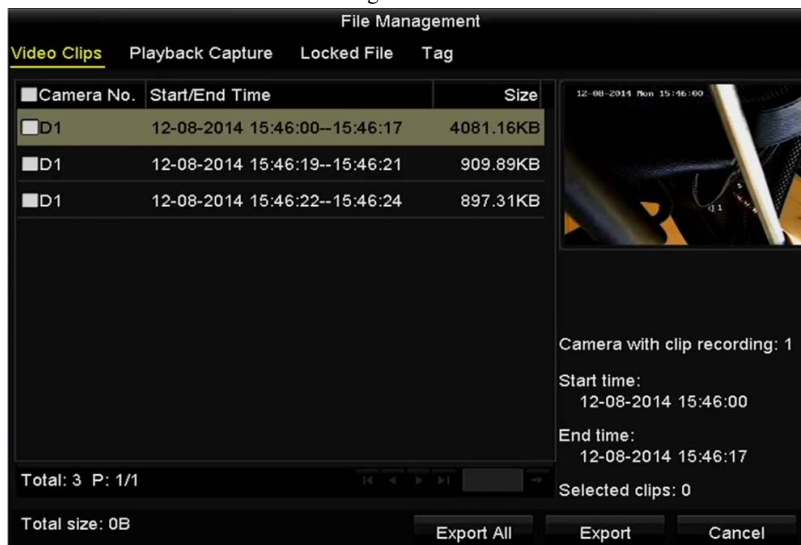

Figure 6.24 File Management

3. You can view the saved video clips, lock/unlock the files and edit the tags which you added in the playback mode.
4. If required, select the items and click **Export All** or **Export** to export the clips/pictures/files/tags to local storage device.

Chapter 7 Backup

7.1 Backing up Record Files

7.1.1 Quick Export

Purpose:

Export record files to backup device(s) quickly.

Steps:

1. Enter Video Export interface.

Menu>Export>Normal

Choose the channel(s) you want to back up and click **Quick Export** button.



The time duration of record files on a specified channel cannot exceed one day. Otherwise, the message box “Max. 24 hours are allowed for quick export.” will pop up.

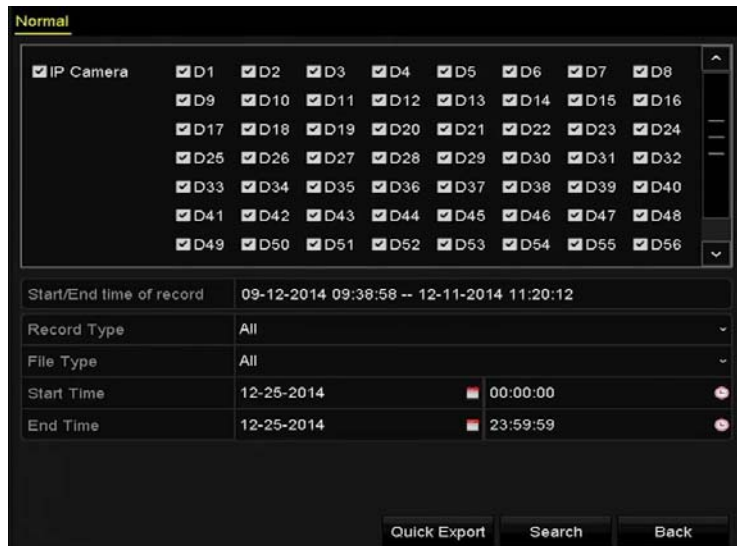

Figure 7. 1 Quick Export Interface

2. Select the format of the log files to be exported. Up to 9 formats are selectable.
3. Click the **Export** to start exporting.



Here we use USB Flash Drive and please refer to the next section Normal Backup for more backup devices supported by the NVR.



Figure 7. 2 Quick Export using USB1-1

Stay in the Exporting interface until all record files are exported.

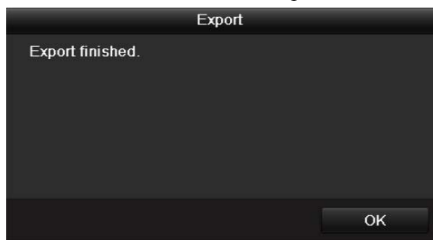

Figure 7. 3 Export Finished

4. Check backup result.

Choose the record file in Export interface and click button to check it.



The Player player.exe will be exported automatically during record file export.



Figure 7. 4 Checkup of Quick Export Result Using USB1-1

7.1.2 Backing up by Normal Video/Picture Search

Purpose:

The record files can be backup to various devices, such as USB devices (USB flash drives, USB HDDs, USB writer) and SATA writer.

Backup using USB flash drives and USB HDDs

Steps:

1. Enter Export interface.
Menu>Export>Normal/Picture
2. Select the cameras to search.
3. Set search condition and click **Search** button to enter the search result interface. The matched video files or pictures are displayed in Chart or List display mode.

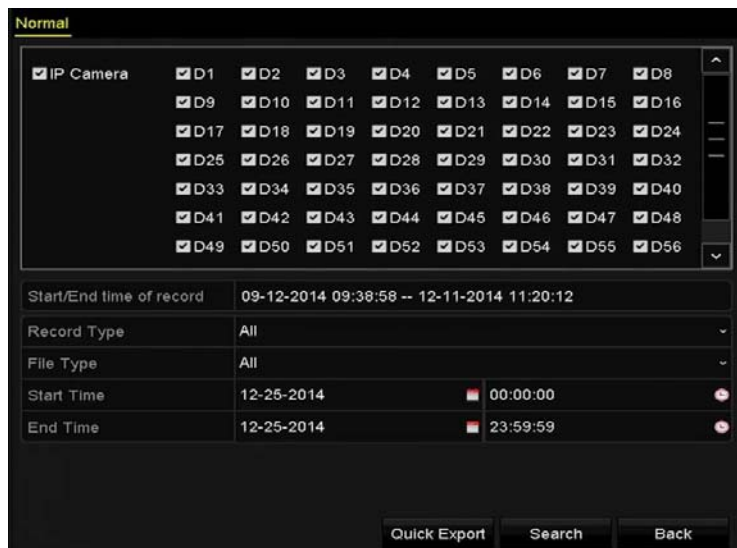



Figure 7. 5 Normal Video Search for Backup

4. Select video files or pictures from the Chart or List to export.
Click  to play the record file if you want to check it.
Check the checkbox before the record files you want to back up.



The size of the currently selected files is displayed in the lower-left corner of the window.



Figure 7. 6 Result of Normal Video Search for Backup

5. Export the video files files.

Click **Export All** button to export all the files.

Or you can select recording files you want to back up, and click **Export** button to enter Export interface.



If the inserted USB device is not recognized:

- Click the **Refresh** button.
- Reconnect device.
- Check for compatibility from vendor.

You can also format USB flash drives or USB HDDs via the device.



Figure 7. 7 Export by Normal Video Search using USB Flash Drive

Stay in the Exporting interface until all record files are exported with pop-up message box “Export finished”.



Figure 7. 8 Export Finished



The backup of video files using USB writer or SATA writer has the same operating instructions. Please refer to steps described above.

7.1.3 Backing up by Event Search

Purpose:

Back up event-related record files using USB devices (USB flash drives, USB HDDs, USB writer), SATA writer or eSATA HDD. Quick Backup and Normal Backup are supported.

Steps:

1. Enter Export interface.
Menu>Export>Event
2. Select the cameras to search.
3. Select the event type to alarm input, motion or VCA.

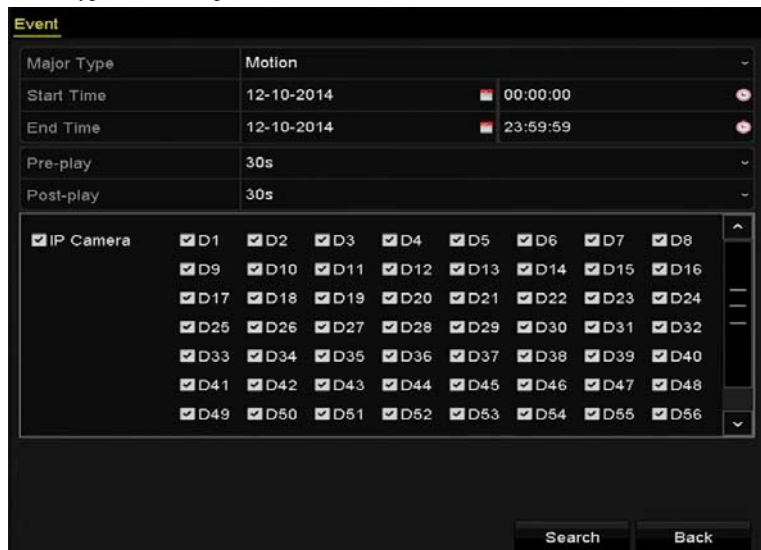

Figure 7. 9 Event Search for Backup

4. Set search condition and click **Search** button to enter the search result interface. The matched video files are displayed in Chart or List display mode.
5. Select video files from the Chart or List interface to export.



Figure 7. 10 Result of Event Search



6. Export the video files.

7.1.4 Backing up Video Clips

Purpose:

You may also select video clips to export directly during Playback, using USB devices (USB flash drives, USB HDDs, USB writer) or SATA writer.

Steps:

1. Enter Playback interface.
2. During playback, use buttons  or  in the playback toolbar to start or stop clipping record file(s).
3. Click the  to enter the file management interface.

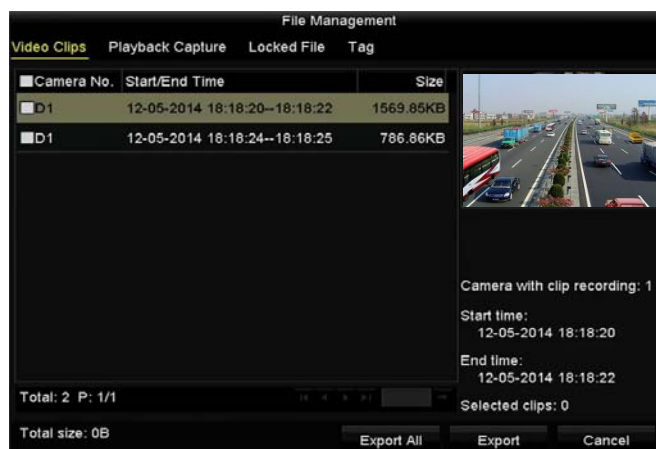

Figure 7. 11 Video Clips Export Interface

7. Export the video clips or captured pictures in playback.

7.2 Managing Backup Devices

Management of USB flash drives and USB HDDs

Steps:

1. Enter the Export interface.



Figure 7. 12 Storage Device Management

2. Backup device management.

Click **New Folder** button if you want to create a new folder in the backup device.

Select a record file or folder in the backup device and click button if you want to delete it.

Click **Erase** button if you want to erase the files from a re-writable CD/DVD.

Click **Format** button to format the backup device.



If the inserted storage device is not recognized:

- Click the **Refresh** button.
- Reconnect device.
- Check for compatibility from vendor.

7.3 Hot Spare Device Backup

Purpose:

The device can form an N+1 hot spare system. The system consists of several working devices and a hot spare device; when the working device fails, the hot spare device switches into operation, thus increasing the reliability of the system.



Please contact dealer for details of models which support the hot spare function.

Before you start:

At least 2 devices are online.

A bidirectional connection shown in the figure below is required to be built between the hot spare device and each working device.

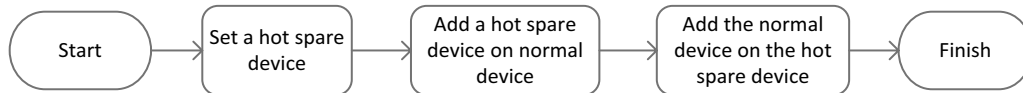

Figure 7. 13 Building Hot Spare System

7.3.1 Setting Hot Spare Device



- The camera connection will be disabled when the device works in the hot spare mode.
- It's highly recommended to restore the defaults of the device after switching the working mode of the hot spare device to normal mode to ensure the normal operation afterwards.

Steps:

1. Enter the Hot Spare settings interface.
Menu > Configuration > Hot Spare
2. Set the **Work Mode** as **Hot Spare Mode** and click the **Apply** button to confirm the settings.
3. Reboot the device to make the change take effect.



Figure 7. 14 Reboot Attention

4. Click the **Yes** button in the pop-up attention box.

7.3.2 Setting Working Device

Steps:

1. Enter the Hot Spare settings interface.
Menu > Configuration > Hot Spare
2. Set the Work Mode as Normal Mode (default).
3. Check the checkbox of Enable to enable the hot spare function.
4. Enter the IP address and admin password of hot spare device.

The screenshot shows a configuration window titled 'General' with the following fields and values:

Work Mode	
<input type="radio"/> Normal Mode	<input type="radio"/> Hot Spare Mode
Enable	<input checked="" type="checkbox"/>
IPv4 address of the hot s...	172 .6 .23 .187
Password of the hot spar...	*****
Working Status	Connected

Note: After the hot spare is enabled, you must link the working device to the hot spare device, otherwise, this function is not available.

Figure 7. 15 Setting Working Mode for Working device

5. Click the **Apply** button to save the settings.

7.3.3 Managing Hot Spare System

Steps:

1. Enter the Hot Spare Settings interface of the hot spare device.
Menu > Configuration > Hot Spare
The connected working device is displayed on the device list.
2. Check the checkbox to select the working device from the device list, and click the **Add** button to link the working device to the hot spare device.



A hot spare device can connect up to 32 working devices.

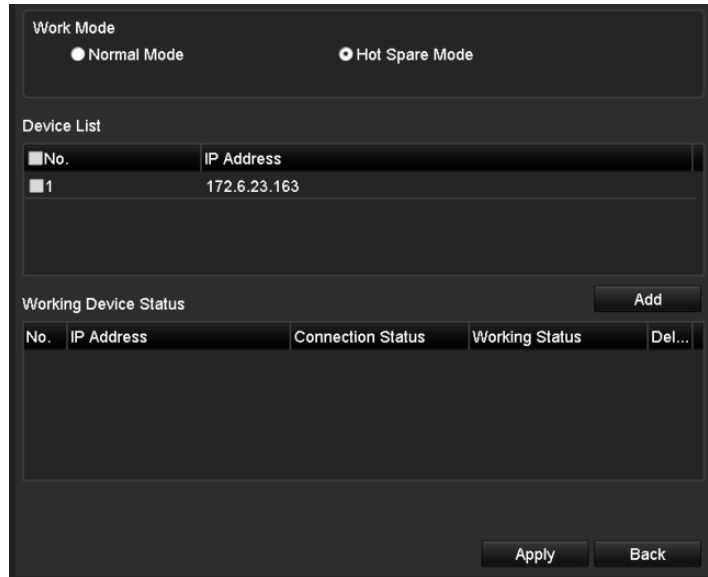

Figure 7. 16 Add Working Device

- You can view the working status of the hot spare device on the Working Status list.
When the working device works properly, the working status of the hot spare device is displayed as *No record*.

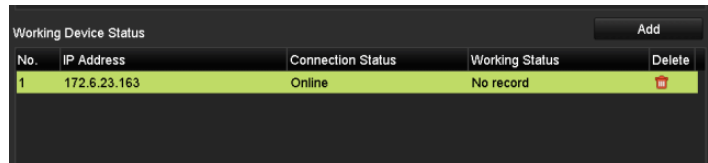

Figure 7. 17 No Recording

When the working device gets offline, the hot spare device will record the video of the IP Camera connected to the working device for backup, and the working status of the hot spare device is displayed as *Backing up*.



The record backing up can be functioned for 1 working device at a time.

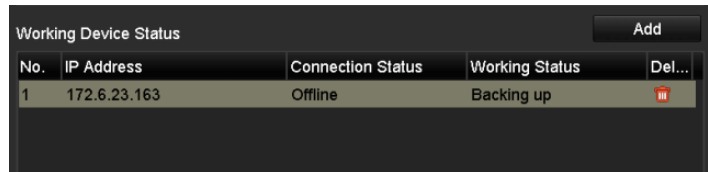

Figure 7. 18 Backing up

When the working device comes online, the lost video files will be restored by the record synchronization function, and the working status of the hot spare device is displayed as *Synchronizing*.



The record synchronization function can be enabled for 1 working device at a time.

No.	IP Address	Connection Status	Working Status	Del...
1	172.6.23.163	Online	Synchronizing (99%)	

Figure 7. 19 Synchronizing

Chapter 8 Alarm Settings

8.1 Setting Motion Detection Alarm

Steps:

1. Enter Motion Detection interface of Camera Management and choose a camera you want to set up motion detection.

Menu> Camera> Motion

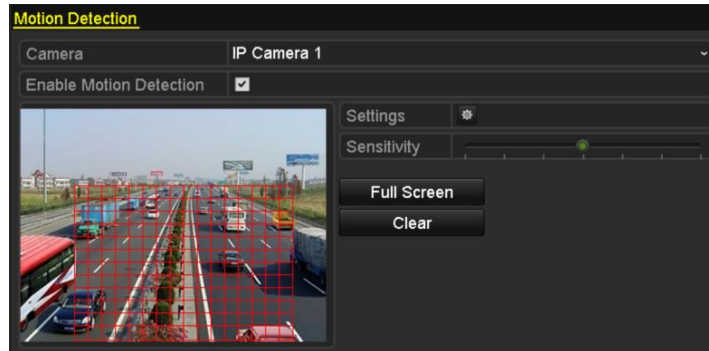

Motion Detection Setup Interface

2. Set up detection area and sensitivity.
 - Tick “Enable Motion Detection”, use the mouse to draw detection area(s) and drag the sensitivity bar to set sensitivity.
 - Click  button and set alarm response actions.
3. Click **Trigger Channel** tab and select one or more channels which will start to record or become full-screen monitoring when motion alarm is triggered, and click **Apply** to save the settings.



Figure 8. 1 Set Trigger Camera of Motion Detection

4. Set up arming schedule of the channel.
 - 1) Select Arming Schedule tab to set the arming schedule of handling actions for the motion detection.
 - 2) Choose one day of a week and up to eight time periods can be set within each day.
 - 3) Click **Apply** to save the settings



Time periods shall not be repeated or overlapped.



Figure 8. 2 Set Arming Schedule of Motion Detection

5. Click **Handling** tab to set up alarm response actions of motion alarm.
6. If you want to set motion detection for another channel, repeat the above steps or just click **Copy** in the Motion Detection interface to copy the above settings to it.

8.2 Setting Sensor Alarms

Purpose:

Set the handling action of an external sensor alarm.

Steps:

1. Enter Alarm Settings of System Configuration and select an alarm input.

Menu> Configuration> Alarm

Select Alarm Input tab to enter Alarm Input Settings interface.

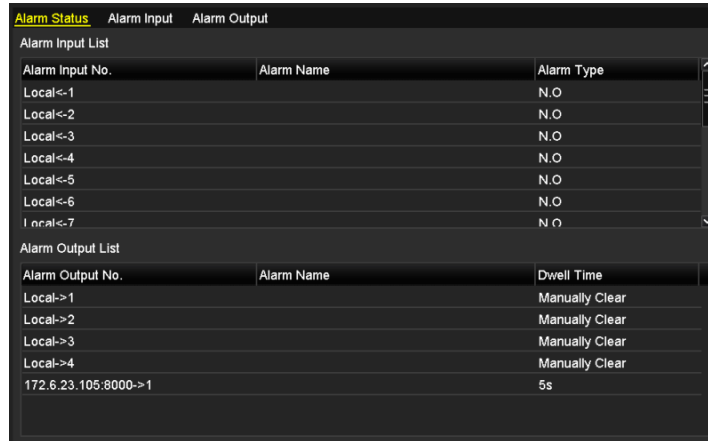

Figure 8.3 Alarm Status Interface of System Configuration

2. Set up the handling action of the selected alarm input.

Check the **Enable** checkbox and click **Settings** button to set up its alarm response actions.



Figure 8.4 Alarm Input Setup Interface

3. Select Trigger Channel tab and select one or more channels which will start to record or become full-screen monitoring when an external alarm is input, and click **Apply** to save the settings.
4. Select **Arming Schedule** tab to set the arming schedule of handling actions.



Figure 8. 5 Set Arming Schedule of Alarm Input

Choose one day of a week and Max. eight time periods can be set within each day, and click **Apply** to save the settings.



Time periods shall not be repeated or overlapped.

Repeat the above steps to set up arming schedule of other days of a week. You can also use **Copy** button to copy an arming schedule to other days.

5. Select **Linkage Action** tab to set up alarm response actions of the alarm input (please refer to *Chapter Setting Alarm Response Actions*).
6. If necessary, select **PTZ Linking** tab and set PTZ linkage of the alarm input.
Set PTZ linking parameters and click **OK** to complete the settings of the alarm input.



Please check whether the PTZ or speed dome supports PTZ linkage.

One alarm input can trigger presets, patrol or pattern of more than one channel. But presets, patrols and patterns are exclusive.

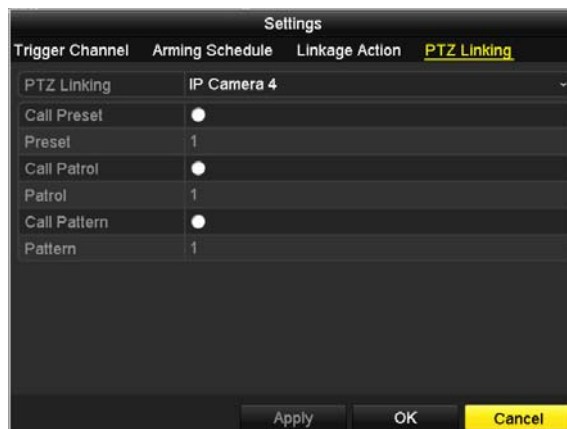

Figure 8. 6 Set PTZ Linking of Alarm Input

7. If you want to set handling action of another alarm input, repeat the above steps.
Or you can click the **Copy** button on the Alarm Input Setup interface and check the checkbox of alarm inputs

to copy the settings to them.



Figure 8. 7 Copy Settings of Alarm Input

8.3 Detecting Video Loss Alarm

Purpose:

Detect video loss of a channel and take alarm response action(s).

Steps:

1. Enter Video Loss interface of Camera Management and select a channel you want to detect.
Menu> Camera> Video Loss

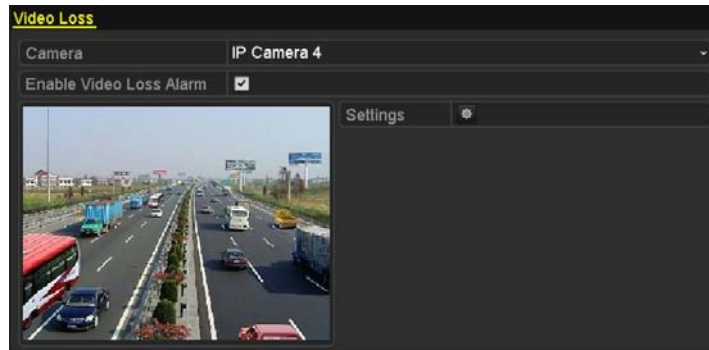



Figure 8. 8 Video Loss Setup Interface

2. Set up handling action of video loss.
Check the checkbox of “Enable Video Loss Alarm”, and click  button to set up handling action of video loss.
3. Set up arming schedule of the handling actions.
 - 1) Select Arming Schedule tab to set the channel’s arming schedule.
 - 2) Choose one day of a week and up to eight time periods can be set within each day.
 - 3) Click **Apply** button to save the settings.



NOTE Time periods shall not be repeated or overlapped.

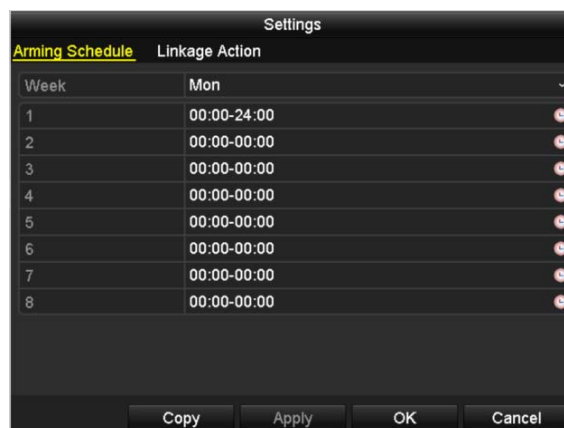

Figure 8. 9 Set Arming Schedule of Video Loss

4. Select **Linkage Action** tab to set up alarm response action of video loss (please refer to *Chapter Setting Alarm Response Actions*).
5. Click the **OK** button to complete the video loss settings of the channel.

8.4 Detecting Video Tampering Alarm

Purpose:

Trigger alarm when the lens is covered and take alarm response action(s).

Steps:

1. Enter Video Tampering interface of Camera Management and select a channel you want to detect video tampering.

Menu> Camera> Video Tampering

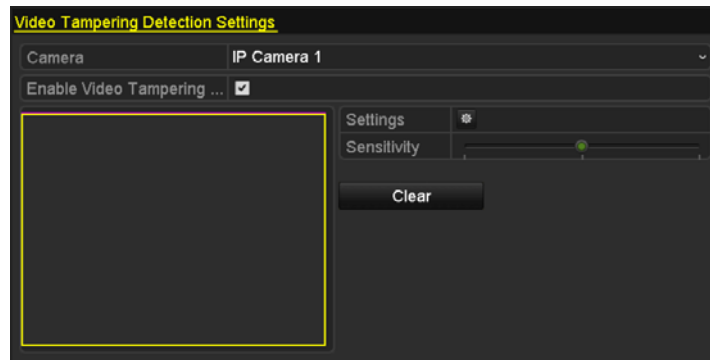



Figure 8. 10 Video Tampering Setting Interface

2. Set the video tampering handling action of the channel.
 - Check the checkbox of “Enable Video Tampering Detection”.
 - Drag the sensitivity bar to set a proper sensitivity level. Use the mouse to draw an area you want to detect video tampering.
 - Click  button to set up handling action of video tampering.
3. Set arming schedule and alarm response actions of the channel.
 - 1) Click Arming Schedule tab to set the arming schedule of handling actions.
 - 2) Choose one day of a week and Max. eight time periods can be set within each day.
 - 3) Click **Apply** button to save the settings.



Time periods shall not be repeated or overlapped.

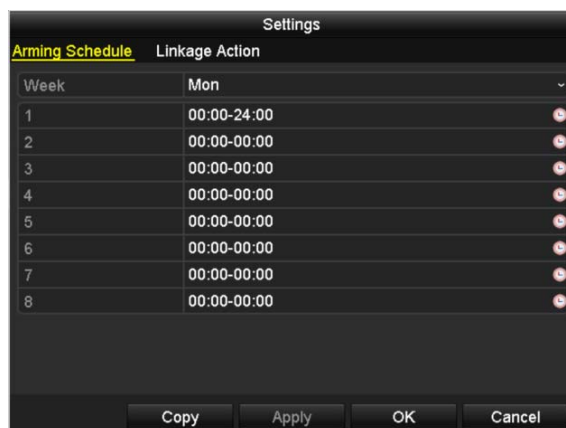

Figure 8. 11 Set Arming Schedule of Video Tampering

4. Select **Linkage Action** tab to set up alarm response actions of video tampering alarm (please refer to *Chapter Setting Alarm Response Actions*).
5. Click the **OK** button to complete the video tampering settings of the channel.

8.5 Handling Exceptions Alarm

Purpose:

Exception settings refer to the handling action of various exceptions, e.g.

- **HDD Full:** The HDD is full.
- **HDD Error:** Writing HDD error or unformatted HDD.
- **Network Disconnected:** Disconnected network cable.
- **IP Conflicted:** Duplicated IP address.
- **Illegal Login:** Incorrect user ID or password.
- **Record Exception:** No space for saving recorded files.
- **Hot Spare Exception:** Disconnected with the working device.

Steps:

Enter Exception interface of System Configuration and handle various exceptions.

Menu> Configuration> Exceptions

Please refer to *Chapter Setting Alarm Response Actions* for detailed alarm response actions.



Figure 8. 12 Exceptions Setup Interface

8.6 Setting Alarm Response Actions

Purpose:

Alarm response actions will be activated when an alarm or exception occurs, including Event Hint Display, Full Screen Monitoring, Audible Warning (buzzer), Notify Surveillance Center, Trigger Alarm Output and Send Email.

Event Hint Display

When an event or exception happens, a hint can be displayed on the lower-left corner of live view image. And you can click the hint icon to check the details. Besides, the event to be displayed is configurable.

Steps:

1. Enter the Exception settings interface.
Menu > Configuration > Exceptions
2. Check the checkbox of **Enable Event Hint**.

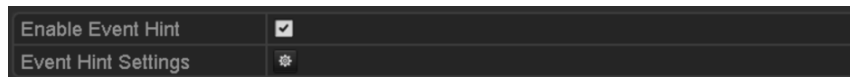

Figure 8. 13 Event Hint Settings Interface

3. Click the  to set the type of event to be displayed on the image.



Figure 8. 14 Event Hint Settings Interface

4. Click the **OK** button to finish settings.

Full Screen Monitoring

When an alarm is triggered, the local monitor (VGA, HDMI or BNC monitor) display in full screen the video image from the alarming channel configured for full screen monitoring.

If alarms are triggered simultaneously in several channels, their full-screen images will be switched at an interval of 10 seconds (default dwell time). A different dwell time can be set by going to Menu > Configuration > Live View > Full Screen Monitoring Dwell Time.

Auto-switch will terminate once the alarm stops and you will be taken back to the Live View interface.



You must select during “Trigger Channel” settings the channel(s) you want to make full screen monitoring.

Audible Warning

Trigger an audible *beep* when an alarm is detected.

Notify Surveillance Center

Sends an exception or alarm signal to remote alarm host when an event occurs. The alarm host refers to the PC installed with Remote Client.



The alarm signal will be transmitted automatically at detection mode when remote alarm host is configured.

Email Linkage

Send an email with alarm information to a user or users when an alarm is detected.

Please refer to *Chapter Configuring Email* for details of Email configuration.

Trigger Alarm Output

Trigger an alarm output when an alarm is triggered.

1. Enter Alarm Output interface.

Menu> Configuration> Alarm> Alarm Output

Select an alarm output and set alarm name and dwell time. Click **Schedule** button to set the arming schedule of alarm output.



If “Manually Clear” is selected in the dropdown list of Dwell Time, you can clear it only by going to Menu> Manual> Alarm.

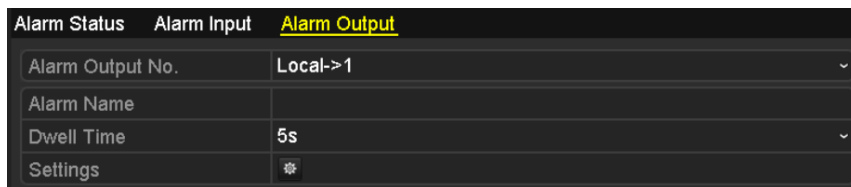

Figure 8. 15 Alarm Output Setup Interface

2. Set up arming schedule of the alarm output.

Choose one day of a week and up to 8 time periods can be set within each day.



Time periods shall not be repeated or overlapped.

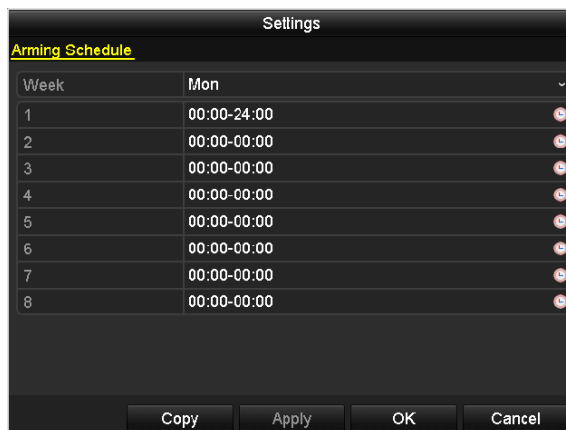

Figure 8. 16 Set Arming Schedule of Alarm Output

- Repeat the above steps to set up arming schedule of other days of a week. You can also use **Copy** button to copy an arming schedule to other days.

Click the **OK** button to complete the video tampering settings of the alarm output No..

- You can also copy the above settings to another channel.

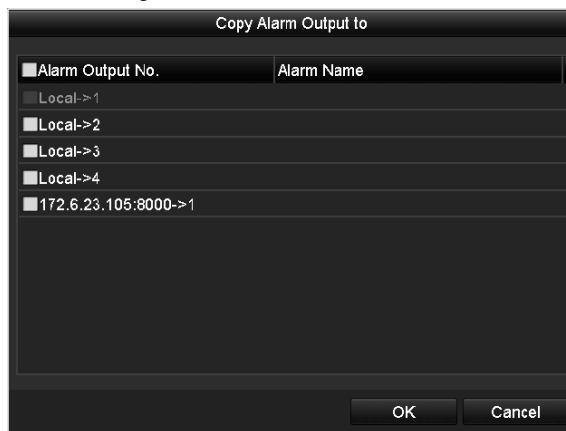

Figure 8. 17 Copy Settings of Alarm Output

8.7 Triggering or Clearing Alarm Output Manually

Purpose:

Sensor alarm can be triggered or cleared manually. If “Manually Clear” is selected in the dropdown list of dwell time of an alarm output, the alarm can be cleared only by clicking **Clear** button in the following interface.

Steps:

Select the alarm output you want to trigger or clear and make related operations.

Menu> Manual> Alarm

Click **Trigger/Clear** button if you want to trigger or clear an alarm output.

Click **Trigger All** button if you want to trigger all alarm outputs.

Click **Clear All** button if you want to clear all alarm output.

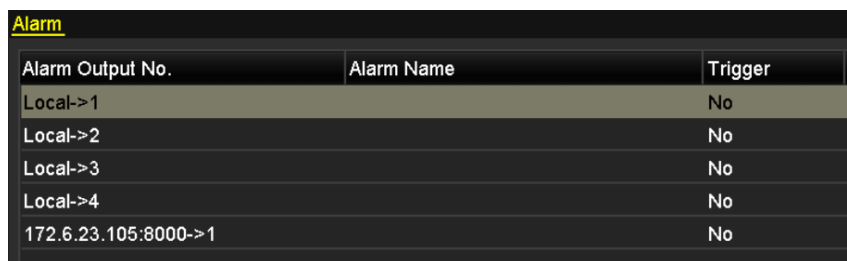

Alarm Output No.	Alarm Name	Trigger
Local->1		No
Local->2		No
Local->3		No
Local->4		No
172.6.23.105:8000->1		No

Figure 8. 18 Clear or Trigger Alarm Output Manually

Chapter 9 VCA Alarm

The NVR supports the VCA detection alarm (*face detection, vehicle detection, line crossing detection and intrusion detection, region entrance detection, region exiting detection, loitering detection, people gathering detection, fast moving detection, parking detection, unattended baggage detection, object removal detection, audio loss exception detection, sudden change of sound intensity detection, and defocus detection*) sent by IP camera. The VCA detection must be enabled and configured on the IP camera settings interface first.



- All VCA detection must be supported by the connected IP camera.
- Please refer to the User Manual of Network Camera for the detailed instructions for the all VCA detection types.

9.1 Face Recognition

Steps:

1. Enter the Face Detection settings interface.
Menu> Camera> VCA
2. Check the checkbox of Enable **Face Recognition**.
3. Click **Save** to save the settings.

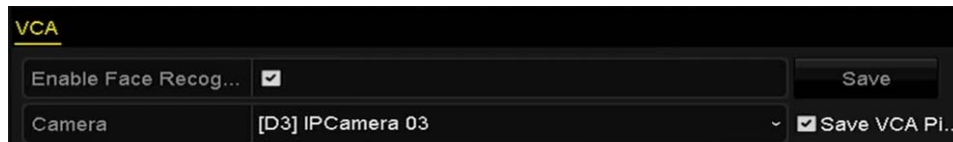

Figure 9. 1 Face Recognition

9.2 Face Detection

Purpose:

Face detection function detects the face appears in the surveillance scene, and some certain actions can be taken when the alarm is triggered.

Steps:

1. Enter the VCA settings interface.
Menu> Camera> VCA
2. Select the camera to configure the VCA.

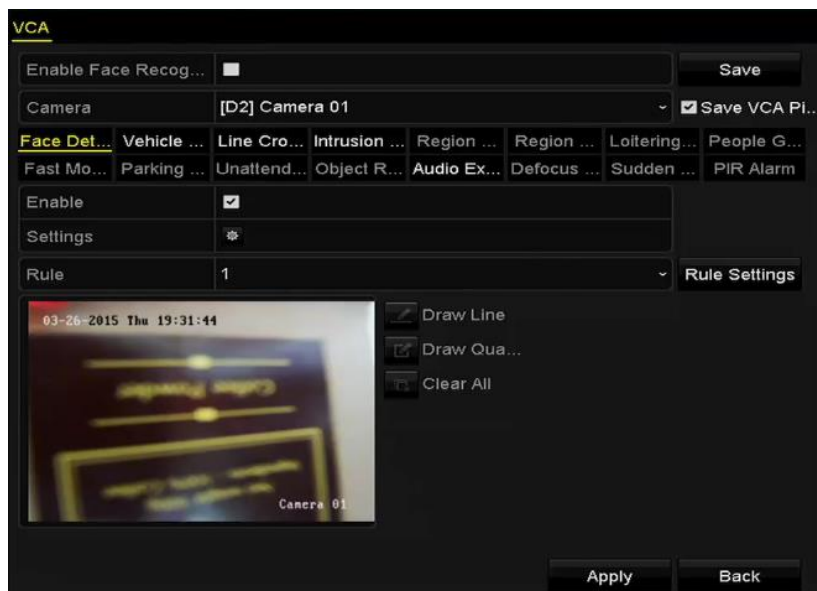



Figure 9. 2 Face Detection

3. Select the VCA detection type to **Face Detection**.
4. Check the **Enable** checkbox to enable this function.
5. Click  to enter the face detection settings interface. Configure the trigger channel, arming schedule and linkage action for the face detection alarm.
6. Click the **Rule Settings** button to set the face detection rules. You can click-and-drag the slider to set the detection sensitivity.

Sensitivity: Range [1-5]. The higher the value is, the more easily the face can be detected.

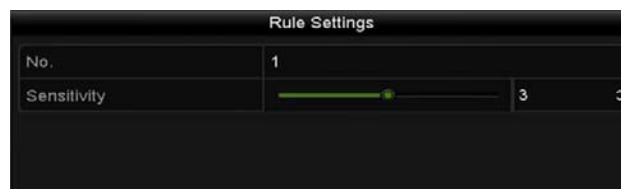

Figure 9. 3 Set Face Detection Sensitivity

7. Click **Apply** to activate the settings.

9.3 Line Crossing Detection

Purpose:

This function can be used for detecting people, vehicles and objects cross a set virtual line. The line crossing direction can be set as bidirectional, from left to right or from right to left. And you can set the duration for the alarm response actions, such as full screen monitoring, audible warning, etc.

Steps:

1. Enter the VCA settings interface.
Menu> Camera> VCA
2. Select the camera to configure the VCA.

3. Select the VCA detection type to **Line Crossing Detection**.
4. Check the **Enable** checkbox to enable this function.
5. Click  to configure the trigger channel, arming schedule and linkage actions for the line crossing detection alarm.
6. Click the **Rule Settings** button to set the line crossing detection rules.
 - 1) Select the direction to A<->B, A->B or A<-B.

A<->B: Only the arrow on the B side shows; when an object going across the configured line with both direction can be detected and alarms are triggered.

A->B: Only the object crossing the configured line from the A side to the B side can be detected.

B->A: Only the object crossing the configured line from the B side to the A side can be detected.
 - 2) Click-and-drag the slider to set the detection sensitivity.

Sensitivity: Range [1-100]. The higher the value is, the more easily the detection alarm can be triggered.
 - 3) Click-**OK** to save the rule settings and back to the line crossing detection settings interface.



Figure 9. 4 Set Line Crossing Detection Rules

7. Click  and set two points in the preview window to draw a virtual line.

You can use the  to clear the existing virtual line and re-draw it.



Up to 4 rules can be configured.

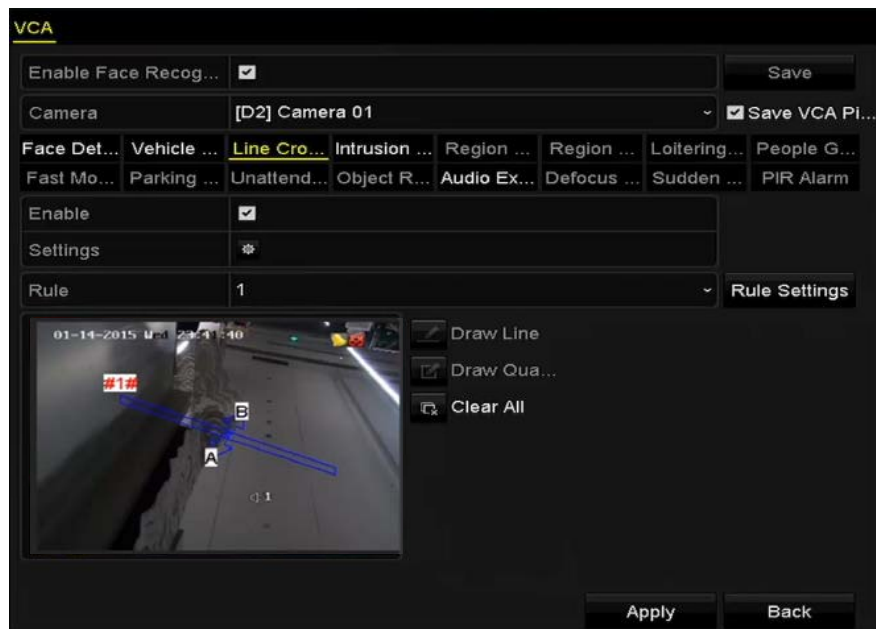

Figure 9. 5 Draw Line for Line Crossing Detection

8. Click **Apply** to activate the settings.

9.4 Intrusion Detection

Purpose:

Intrusion detection function detects people, vehicle or other objects which enter and loiter in a pre-defined virtual region, and some certain actions can be taken when the alarm is triggered.

Steps:



1. Enter the VCA settings interface.
Menu> Camera> VCA
2. Select the camera to configure the VCA.
3. Select the VCA detection type to **Intrusion Detection**.
4. Check the **Enable** checkbox to enable this function.
5. Click  to configure the trigger channel, arming schedule and linkage actions for the line crossing detection alarm.
6. Click the **Rule Settings** button to set the intrusion detection rules. Set the following parameters.
 - 1) **Threshold:** Range [1s-10s], the threshold for the time of the object loitering in the region. When the duration of the object in the defined detection area is longer than the set time, the alarm will be triggered.
 - 2) Click-and-drag the slider to set the detection sensitivity.
Sensitivity: Range [1-100]. The value of the sensitivity defines the size of the object which can trigger the alarm. The higher the value is, the more easily the detection alarm can be triggered.
 - 3) **Percentage:** Range [1-100]. Percentage defines the ratio of the in-region part of the object which can trigger the alarm. For example, if the percentage is set as 50%, when the object enters the region and occupies half of the whole region, the alarm is triggered.



Figure 9. 6 Set Intrusion Crossing Detection Rules

- 4) Click-**OK** to save the rule settings and back to the line crossing detection settings interface.
7. Click  and draw a quadrilateral in the preview window by specifying four vertexes of the detection region, and right click to complete drawing. Only one region can be configured.

You can use the  to clear the existing virtual line and re-draw it.



Up to 4 rules can be configured.

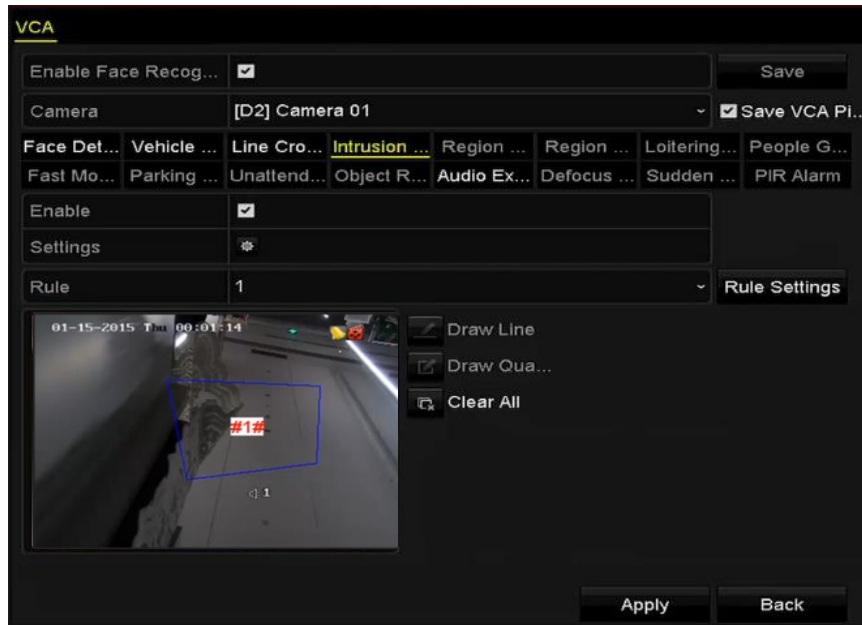

Figure 9. 7 Draw Area for Intrusion Detection



8. Click **Apply** to save the settings.

9.5 Region Entrance Detection

Purpose:

Region entrance detection function detects people, vehicle or other objects which enter a pre-defined virtual region from the outside place, and some certain actions can be taken when the alarm is triggered.

Steps:

1. Enter the VCA settings interface.
Menu> Camera> VCA
2. Select the camera to configure the VCA.
3. Select the VCA detection type to **Region Entrance Detection**.
4. Check the **Enable** checkbox to enable this function.
5. Click  to configure the trigger channel, arming schedule and linkage actions for the line crossing detection alarm.
6. Click the **Rule Settings** button to set the sensitivity of the region entrance detection.
Sensitivity: Range [0-100]. The higher the value is, the more easily the detection alarm can be triggered.
7. Click  and draw a quadrilateral in the preview window by specifying four vertexes of the detection region, and right click to complete drawing. Only one region can be configured.

You can use the  to clear the existing virtual line and re-draw it.

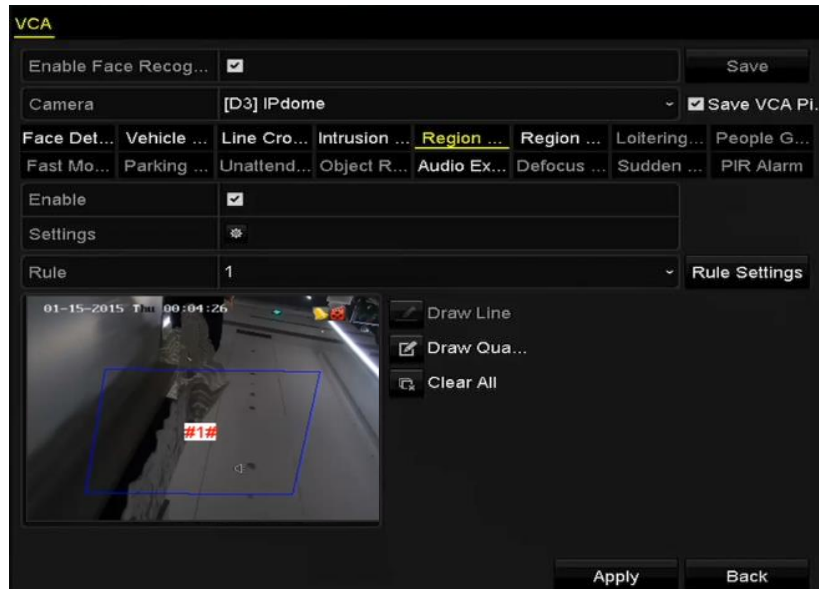

Figure 9. 8 Set Region Entrance Detection



Up to 4 rules can be configured.

8. Click **Apply** to save the settings.

9.6 Region Exiting Detection

Purpose:

Region exiting detection function detects people, vehicle or other objects which exit from a pre-defined virtual region, and some certain actions can be taken when the alarm is triggered.



- Up to 4 rules can be configured.

9.7 Loitering Detection

Purpose:

Loitering detection function detects people, vehicle or other objects which loiter in a pre-defined virtual region for some certain time, and a series of actions can be taken when the alarm is triggered.



- The **Threshold** [1s-10s] in the Rule Settings defines the time of the object loitering in the region. If you set the value as 5, alarm is triggered after the object loitering in the region for 5s; and if you set the value as 0, alarm is triggered immediately after the object entering the region.
- Up to 4 rules can be configured.

9.8 People Gathering Detection

Purpose:

People gathering detection alarm is triggered when people gather around in a pre-defined virtual region, and a series of actions can be taken when the alarm is triggered.



- The **Percentage** in the Rule Settings defines the gathering density of the people in the region. Usually, when the percentage is small, the alarm can be triggered when small number of people gathered in the defined detection region.
- Up to 4 rules can be configured.

9.9 Fast Moving Detection

Purpose:

Fast moving detection alarm is triggered when people, vehicle or other objects move fast in a pre-defined virtual region, and a series of actions can be taken when the alarm is triggered.



- The **Sensitivity** in the Rule Settings defines the moving speed of the object which can trigger the alarm. The higher the value is, the more easily a moving object can trigger the alarm.

- Up to 4 rules can be configured.

9.10 Parking Detection

Purpose:

Parking detection function detects illegal parking in places such as highway, one-way street, etc., and a series of actions can be taken when the alarm is triggered.



- The **Threshold**[5s-20s] in the Rule Settings defines the time of the vehicle parking in the region. If you set the value as 10, alarm is triggered after the vehicle stay in the region for 10s.
- Up to 4 rules can be configured.

9.11 Unattended Baggage Detection

Purpose:

Unattended baggage detection function detects the objects left over in the pre-defined region such as the baggage, purse, dangerous materials, etc., and a series of actions can be taken when the alarm is triggered.



- The **Threshold**[5s-20s] in the Rule Settings defines the time of the objects left over in the region. If you set the value as 10, alarm is triggered after the object is left and stay in the region for 10s. And the **Sensitivity** defines the similarity degree of the background image. Usually, when the sensitivity is high, a very small object left in the region can trigger the alarm.
- Up to 4 rules can be configured.

9.12 Object Removal Detection

Purpose:

Object removal detection function detects the objects removed from the pre-defined region, such as the exhibits on display, and a series of actions can be taken when the alarm is triggered.



- The **Threshold** [5s-20s] in the Rule Settings defines the time of the objects removed from the region. If you set the value as 10, alarm is triggered after the object disappears from the region for 10s. And the **Sensitivity** defines the similarity degree of the background image. Usually, when the sensitivity is high, a very small object taken from the region can trigger the alarm.
- Up to 4 rules can be configured.

9.13 Audio Exception Detection

Purpose:

Audio exception detection function detects the abnormal sounds in the surveillance scene, such as the sudden increase / decrease of the sound intensity, and some certain actions can be taken when the alarm is triggered.

Steps:

1. Enter the VCA settings interface.
Menu> Camera> VCA
2. Select the camera to configure the VCA.
3. Select the VCA detection type to **Audio Exception Detection**.
4. Click  to configure the trigger channel, arming schedule and linkage action for the face detection alarm.
5. Click the **Rule Settings** button to set the audio exception rules.



Figure 9.9 Set Audio Exception Detection Rules

- 1) Check the checkbox of **Audio Input Exception** to enable the audio loss detection function.
- 2) Check the checkbox of **Sudden Increase of Sound Intensity Detection** to detect the sound steep rise in the surveillance scene. You can set the detection sensitivity and threshold for sound steep rise.
Sensitivity: Range [1-100], the smaller the value is, the more severe the change should be to trigger the detection.
Sound Intensity Threshold: Range [1-100], it can filter the sound in the environment, the louder the environment sound, the higher the value should be. You can adjust it according to the real environment.
- 3) Check the checkbox of **Sudden Decrease of Sound Intensity Detection** to detect the sound steep drop in the surveillance scene. You can set the detection sensitivity[1-100] for sound steep drop.
6. Click **Apply** to activate the settings.

9.14 Sudden Scene Change Detection

Purpose:

Scene change detection function detects the change of surveillance environment affected by the external factors; such as the intentional rotation of the camera, and some certain actions can be taken when the alarm is triggered.



- The **Sensitivity** in the Rule Settings ranges from 1 to 100, and the higher the value is, the more easily the change of scene can trigger the alarm.

9.15 Defocus Detection

Purpose:

The image blur caused by defocus of the lens can be detected, and some certain actions can be taken when the alarm is triggered.



- The **Sensitivity** in the Rule Settings ranges from 1 to 100, and the higher the value is, the more easily the defocus image can trigger the alarm.

9.16 PIR Alarm

Purpose:

A PIR (Passive Infrared) alarm is triggered when an intruder moves within the detector's field of view. The heat energy dissipated by a person, or any other warm blooded creature such as dogs, cats, etc., can be detected.

Steps:

1. Enter the VCA settings interface.
Menu> Camera> VCA
2. Select the camera to configure the VCA.
3. Select the VCA detection type to **PIR Alarm**.
4. Click  to configure the trigger channel, arming schedule and linkage action for the PIR alarm.
5. Click the **Rule Settings** button to set the rules.
6. Click **Apply** to activate the settings.

Chapter 10 VCA Search

With the configured VCA detection, the NVR supports the VCA search for the behavior analysis, face capture, people counting and heat map results.

10.1 Face Search

Purpose:

When there are detected face picture captured and saved in HDD, you can enter the Face Search interface to search the picture and play the picture related video file according to the specified conditions.

Before you start:

Please refer to *Chapter Face Detection* for configuring the face detection.

Steps:

1. Enter the **Face Search** interface.
Menu >VCA Search > Face Search
2. Select the camera (s) for the face search.

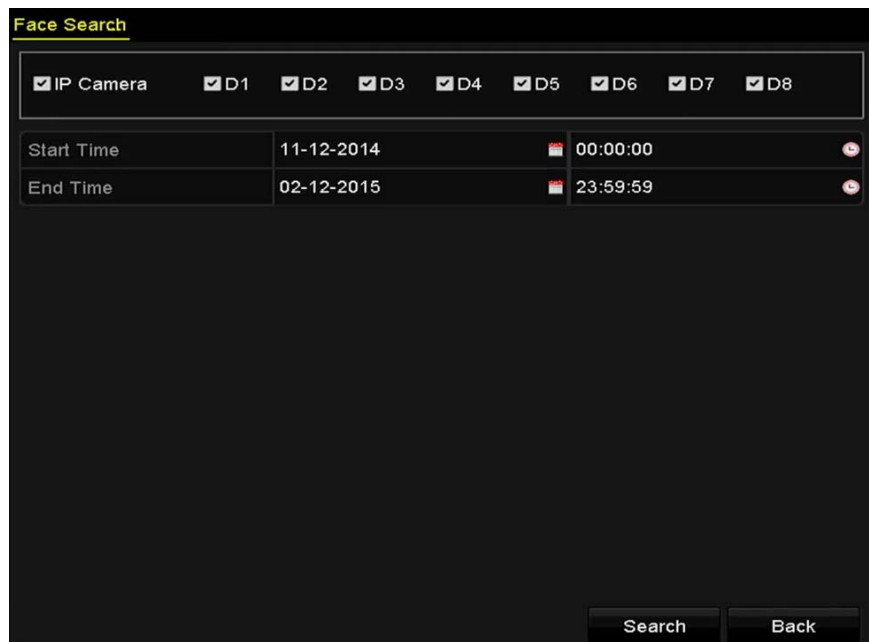



Figure 10. 1 Face Search



3. Specify the start time and end time for search the captured face pictures or video files.
4. Click **Search** to start searching. The search results of face detection pictures are displayed in list or in chart.



Figure 10. 2 Face Search Interface

5. Play the face picture related video file.

You can double click on a face picture to play its related video file in the view window on the top right, or select a picture item and click  to play it.

You can also click  to stop the playing, or click   to play the previous/next file.

6. If you want to export the captured face pictures to local storage device, connect the storage device to the device and click **Export All** to enter the Export interface.

Click **Export** to export all face pictures to the storage device.

Please refer to *ChapterBackup* for the operation of exporting files.



Figure 10. 3 Export Files

10.2 Behavior Search

Purpose:

The behavior analysis detects a series of suspicious behavior based on VCA detection, and certain linkage methods will be enabled if the alarm is triggered.

Steps:

1. Enter the **Behavior Search** interface.
Menu>VCA Search> Behavior Search
2. Select the camera (s) for the behavior search.
3. Specify the start time and end time for searching the matched pictures.

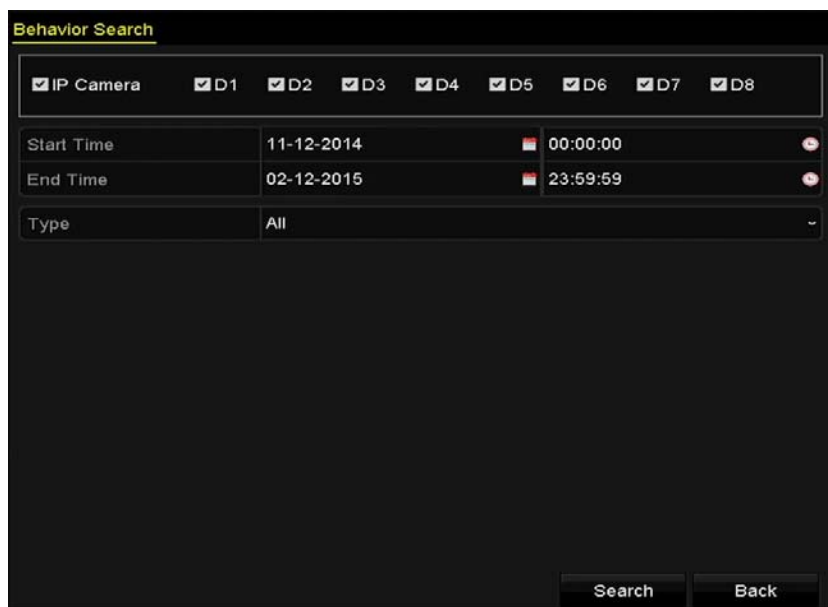



Figure 10. 4 Behavior Search Interface



4. Select the VCA detection type from the dropdown list, including the line crossing detection, intrusion detection, unattended baggage detection, object removal detection, region entrance detection, region exiting detection, parking detection, loitering detection, people gathering detection and fast moving detection.
5. Click **Search** to start searching. The search results of pictures are displayed in list or in chart.



Figure 10. 5 Behavior Search Results

6. Play the behavior analysis picture related video file.

You can double click on a picture from the list to play its related video file in the view window on the top right, or select a picture item and click  to play it.

You can also click  to stop the playing, or click   to play the previous/next file.

7. If you want to export the captured pictures to local storage device, connect the storage device to the device and click **Export All** to enter the Export interface.

Click **Export** to export all pictures to the storage device.

10.3 People Counting

Purpose:

The Counting is used to calculate the number of people entered or left a certain configured area and form in daily/weekly/monthly/annual reports for analysis.

Steps:

1. Enter the Counting interface.
Menu>VCA Search>Counting
2. Select the camera for the people counting.
3. Select the report type to Daily Report, Weekly Report, Monthly Report or Annual Report.
4. Set the statistics time.
5. Click the **Counting** button to start people counting statistics.

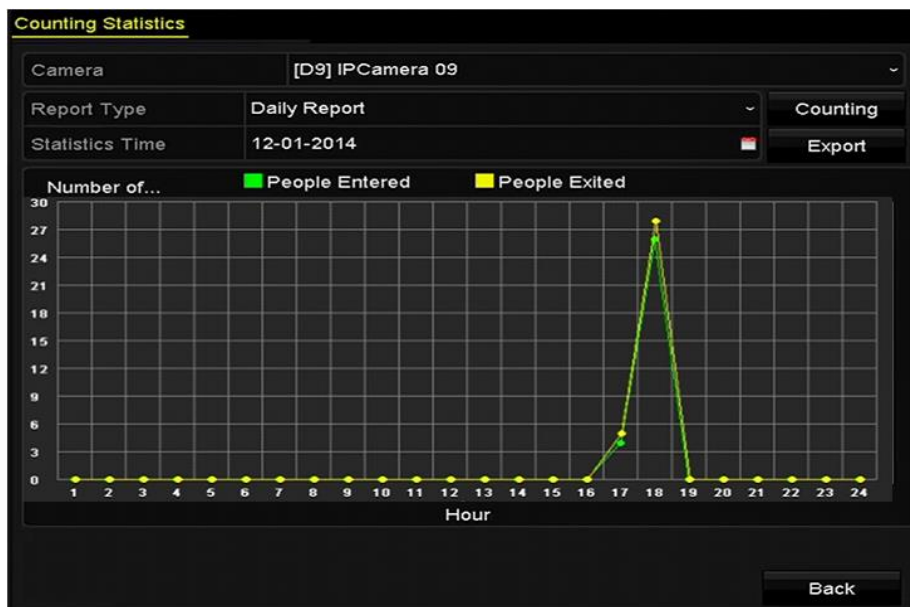

Figure 10. 6 People Counting Interface

6. You can click the **Export** button to export the statistics report in excel format.

10.4 Heat Map

Purpose:

Heat map is a graphical representation of data represented by colors. The heat map function is usually used to analyze the visit times and dwell time of customers in a configured area.



The heat map function must be supported by the connected IP camera and the corresponding configuration must be set.

Steps:

1. Enter the **Heat Map** interface.
Menu > VCA Search > Heat Map
2. Select the camera for the heat map processing.
3. Select the report type to Daily Report, Weekly Report, Monthly Report or Annual Report.
4. Set the statistics time.

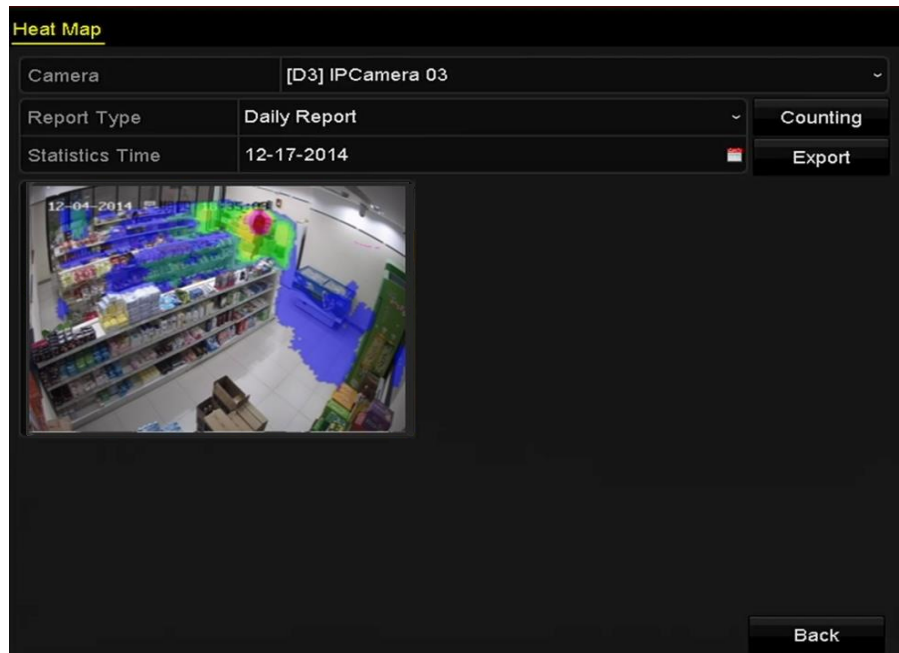

Figure 10. 7 Heat Map Interface

5. Click the **Counting** button to export the report data and start heat map statistics, and the results are displayed in graphics marked in different colors.



As shown in the figure above, red color block (255, 0, 0) indicates the most welcome area, and blue color block (0, 0, 255) indicates the less-popular area.

6. You can click the **Export** button to export the statistics report in excel format.

Chapter 11 Network Settings

11.1 Configuring General Settings

Purpose:

Network settings must be properly configured before you operate NVR over network.

Steps:

1. Enter the Network Settings interface.
Menu > Configuration > Network
2. Select the **General** tab.

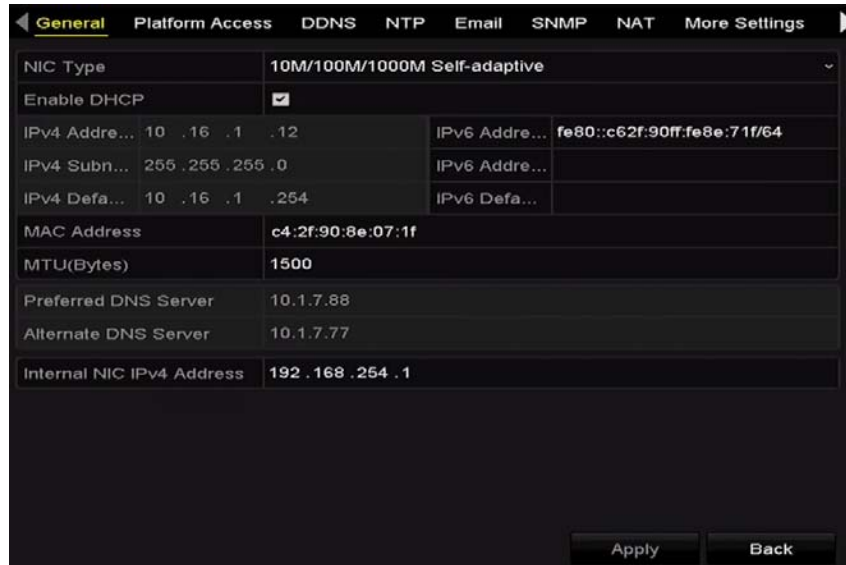

Figure 11. 1 Network Settings Interface

3. In the **General Settings** interface, you can configure the following settings: Working Mode, NIC Type, IPv4 Address, IPv4 Gateway, MTU and DNS Server.



The valid value range of MTU is 500 - 9676.

If the DHCP server is available, you can click the checkbox of **DHCP** to automatically obtain an IP address and other network settings from that server.



- One self-adaptive 10M/100M network interface for 4ch NVR.
- One self-adaptive 10M/100M/1000M network interface for other models.
- For this series NVR, you need to configure the internal NIC address, so that IP addresses are assigned to the cameras connected to the PoE interfaces.

4. After having configured the general settings, click **Apply** button to save the settings.

11.2 Configuring Advanced Settings

11.2.1 Configuring Cloud P2P

Purpose:

Cloud P2P provides the mobile phone application and as well the service platform page to access and manage your connected NVR, which enables you to get a convenient remote access to the surveillance system.

Steps:

1. Enter the Network Settings interface.
Menu > Configuration > Network
2. Select the **Platform Access** tab to enter the Cloud P2P Settings interface.
3. Check the **Enable** checkbox to activate this feature.
4. (Optional) If required, select the checkbox of **Custom** and input the **Server Address**. The default server address is *dev.hicloudcam.com*.
5. To turn the **Enable Stream Encryption** on, you can select its checkbox.
6. Enter the **Verification Code** of the device.



The verification code consists of 6 capital letters and is located at the bottom of the DVR. You can also use the scanning tool of your phone to quickly get the code by scanning the QR code below.

Enable	<input checked="" type="checkbox"/>
Access Type	Cloud P2P
Server Address	dev.hicloudcam.com <input type="checkbox"/> Custom
Enable Stream Encryption	<input type="checkbox"/>
Verification Code	
Status	Offline



Figure 11. 2 Cloud P2P Settings Interface

7. Click the **Apply** button to save and exit the interface.
After configuration, you can access and manage the NVR by your mobile phone on which the Cloud P2P application is installed.

11.2.2 Configuring DDNS

Purpose:

You can set the Dynamic DNS (DDNS) for network access.

Prior registration with your ISP is required before configuring the system to use DDNS.

Steps:

1. Enter the Network Settings interface.
Menu > Configuration > Network
2. Select the **DDNS** tab to enter the DDNS Settings interface.
3. Check the **DDNS** checkbox to enable this feature.
4. Select **DDNS Type**. Five different DDNS types are selectable: IP Server, DynDNS, PeanutHull, NO-IP and SIMPLEDDNS.
 - **IP Server:** Input **Server Address** for IP Server.

Enable DDNS	<input checked="" type="checkbox"/>
DDNS Type	IP Server
Area/Country	Custom
Server Address	172.1.1.1
Device Domain Name	
Status	DDNS is disabled.
User Name	
Password	

Figure 11. 3 IP Server Settings Interface

- **DynDNS:**
 - 1) Enter **Server Address** for DynDNS (i.e. members.dyndns.org).
 - 2) In the **Device Domain Name** text field, enter the domain obtained from the DynDNS website.
 - 3) Enter the **User Name** and **Password** registered in the DynDNS website.

Enable DDNS	<input checked="" type="checkbox"/>
DDNS Type	DynDNS
Area/Country	Custom
Server Address	members.dyndns.org
Device Domain Name	123.dyndns.com
Status	DDNS is disabled.
User Name	test
Password	*****

Figure 11. 4 DynDNS Settings Interface

- **PeanutHull:** Enter the **User Name** and **Password** obtained from the PeanutHull website.

Enable DDNS	<input checked="" type="checkbox"/>
DDNS Type	PeanutHull
Area/Country	Custom
Server Address	
Device Domain Name	
Status	DDNS is disabled.
User Name	123.gcip.net
Password	*****

Figure 11. 5 PeanutHull Settings Interface

- **NO-IP:**

Enter the account information in the corresponding fields. Refer to the DynDNS settings.

- 1) Enter **Server Address** for NO-IP.
- 2) In the **Device Domain Name** text field, enter the domain obtained from the NO-IP website (www.no-ip.com).
- 3) Enter the **User Name** and **Password** registered in the NO-IP website.

Enable DDNS	<input checked="" type="checkbox"/>
DDNS Type	NO-IP
Area/Country	Custom
Server Address	no-ip.org
Device Domain Name	123.no-ip.org
Status	DDNS is disabled.
User Name	test
Password	*****

Figure 11. 6 NO-IP Settings Interface

- **SIMPLEDDNS:**

- 1) Select the continent/country of the server on which the device is registered.
- 2) The **Server Address** of the SIMPLEDDNS server appears by default: www.simpleddns.com.
- 3) Enter the **Device Domain Name**. You can use the alias you registered in the SIMPLEDDNS server or define a new device domain name. If a new alias of the device domain name is defined in the NVR, it will replace the old one registered on the server. You can register the alias of the device domain name in the SIMPLEDDNS server first and then enter the alias to the **Device Domain Name** in the NVR; you can also enter the domain name directly on the NVR to create a new one.

Enable DDNS	<input checked="" type="checkbox"/>
DDNS Type	SIMPLEDDNS
Area/Country	Custom
Server Address	www.simpleddns.com
Device Domain Name	
Status	DDNS is disabled.
User Name	
Password	

Figure 11. 7 SIMPLEDDNS Settings Interface

- **Register the device on the SIMPLEDDNS server.**

- 1) Go to the SIMPLEDDNS website: www.simpleddns.com.

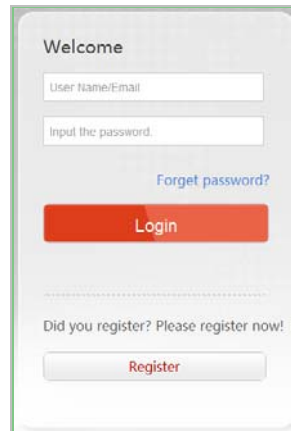

The image shows a login and registration interface. At the top, it says "Welcome". Below that are two input fields: "User Name/Email" and "Input the password.". There is a link for "Forgot password?". A red "Login" button is positioned below the password field. Below a dashed line, it says "Did you register? Please register now!" with a "Register" button.

Figure 11. 8 Register an Account

- 2) Click  to register an account if you do not have one and use the account to log in.

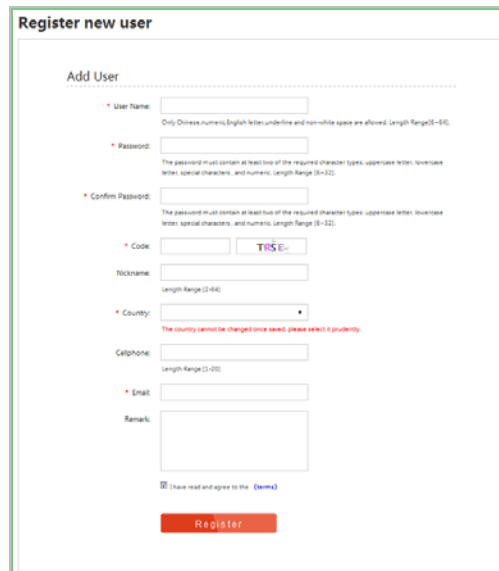

The image shows a "Register new user" form. The title is "Register new user". Below it is "Add User". The form includes several fields with red asterisks indicating required fields: "User Name" (with a note: "Only Chinese, numeric, English letter, underline and non-white space are allowed. Length Range(3-6)"), "Password" (with a note: "The password must contain at least two of the required character types: uppercase letter, lowercase letter, special characters, and numeric. Length Range (8-12)"), "Confirm Password" (with a note: "The password must contain at least two of the required character types: uppercase letter, lowercase letter, special characters, and numeric. Length Range (8-12)"), "Code" (with a "TIRE" button), "Nickname" (with a note: "Length Range (2-6)"), "Country" (with a note: "The country cannot be changed once saved, please select it prudently."), "Cellphone" (with a note: "Length Range (1-10)"), "Email", and "Remark". At the bottom, there is a checkbox for "I have read and agree to the Terms" and a red "Register" button.

Figure 11. 9 Register an Account

- 3) In the Device Management interface, click  to register the device.

Figure 11. 10 Register the Device

- 4) Input **Device Serial No.**, **Device Domain (Device Name)** and **HTTP Port**. And click **OK** to add the device.

➤ **Access the Device via Web Browser or Client Software**

After having successfully registered the device on the SIMPLEDDNS server, you can access your device via web browser or Client Software with the **Device Domain Name (Device Name)**.

● **OPTION 1: Access the Device via Web Browser**

Open a web browser, and enter <http://www.simpleddns.com/alias> in the address bar. Alias refers to the **Device Domain Name** on the device or the **Device Name** on the SIMPLEDDNS server.

Example: <http://www.simpleddns.com/nvr>



If you mapped the HTTP port on your router and changed it to port No. except 80, you have to enter <http://www.simpleddns.com/alias:HTTP port> in the address bar to access the device.

● **OPTION 2: Access the devices via CMS**

For CMS, in the Add Device window, select **SIMPLEDDNS** and then edit the device information.

Nickname: Edit a name for the device as you want.

Server Address: www.simpleddns.com

Device Domain Name: It refers to the **Device Domain Name** on the device or the **Device Name** on the SIMPLEDDNS server you created.

User Name: Enter the user name of the device.

Password: Enter the password of the device.

5. Click the **Apply** button to save the settings.

After setting all the required parameters for the DDNS, you can view the connecting status of the device by checking the **Status** information..

11.2.3 Configuring NTP Server

Purpose:

A Network Time Protocol (NTP) Server can be configured on your NVR to ensure the accuracy of system date/time.

Steps:

1. Enter the Network Settings interface.
Menu >Configuration> Network
2. Select the **NTP** tab to enter the NTP Settings interface, as shown in Figure 11. 11.

Enable NTP	<input checked="" type="checkbox"/>
Interval (min)	60
NTP Server	
NTP Port	123

Figure 11. 11 NTP Settings Interface

3. Check the **Enable NTP** checkbox to enable this feature.
4. Configure the following NTP settings:
 - **Interval:** Time interval between the two synchronizing actions with NTP server. The unit is minute.
 - **NTP Server:** IP address of NTP server.
 - **NTP Port:** Port of NTP server.
5. Click the **Apply** button to save and exit the interface.



The time synchronization interval can be set from 1 to 10080min, and the default value is 60min. If the NVR is connected to a public network, you should use a NTP server that has a time synchronization function, such as the server at the National Time Center (IP Address: 210.72.145.44). If the NVR is setup in a more customized network, NTP software can be used to establish a NTP server used for time synchronization.

11.2.4 Configuring SNMP

Purpose:

You can use SNMP protocol to get device status and parameters related information.

Steps:

1. Enter the Network Settings interface.
Menu >Configuration> Network
2. Select the **SNMP** tab to enter the SNMP Settings interface, as shown in Figure 11. 12.

Enable SNMP	<input checked="" type="checkbox"/>
SNMP Version	V2
SNMP Port	161
Read Community	public
Write Community	private
Trap Address	
Trap Port	162

Figure 11. 12 SNMP Settings Interface

3. Check the **SNMP** checkbox to enable this feature.
4. The enabling of SNMP may cause security problems. Click **Yes** to continue or **No** to cancel the operation.



Figure 11. 13 SNMP Settings Interface

5. When you choose the Yes option in step4, configure the following SNMP settings:
 - **Trap Address:** IP Address of SNMP host.
 - **Trap Port:** Port of SNMP host.
6. Click the **Apply** button to save and exit the interface.



Before setting the SNMP, please download the SNMP software and manage to receive the device information via SNMP port. By setting the Trap Address, the NVR is allowed to send the alarm event and exception message to the surveillance center.

11.2.5 Configuring More Settings

Steps:

1. Enter the Network Settings interface.
Menu > Configuration > Network
2. Select the **More Settings** tab to enter the More Settings interface.

Alarm Host IP	
Alarm Host Port	0
Server Port	8000
HTTP Port	80
Multicast IP	
RTSP Port	554

Figure 11. 14 More Settings Interface

3. Configure the remote alarm host, server port, HTTP port, multicast, RTSP port.
 - **Alarm Host IP/Port:** With a remote alarm host configured, the device will send the alarm event or exception message to the host when an alarm is triggered. The remote alarm host must have the CMS (Client Management System) software installed.
The **Alarm Host IP** refers to the IP address of the remote PC on which the CMS (Client Management System) software is installed, and the **Alarm Host Port** must be the same as the alarm monitoring port configured in the software (default port is 7200).
 - **Multicast IP:** The multicast can be configured to realize live view for more than the maximum number of cameras through network. A multicast address spans the Class-D IP range of 224.0.0.0 to 239.255.255.255. It is recommended to use the IP address ranging from 239.252.0.0 to 239.255.255.255.
When adding a device to the CMS (Client Management System) software, the multicast address must be the same as the device's multicast IP.
 - **RTSP Port:** The RTSP (Real Time Streaming Protocol) is a network control protocol designed for use in entertainment and communications systems to control streaming media servers.
Enter the RTSP port in the text field of **RTSP Port**. The default RTSP port is 554, and you can change

it according to different requirements.

- **Server Port** and **HTTP Port**: Enter the **Server Port** and **HTTP Port** in the text fields. The default Server Port is 8000 and the HTTP Port is 80, and you can change them according to different requirements.



The Server Port should be set to the range of 2000-65535 and it is used for remote client software access. The HTTP port is used for remote IE access.

Alarm Host IP	192.0.0.10
Alarm Host Port	7200
Server Port	8000
HTTP Port	80
Multicast IP	239.252.2.50
RTSP Port	554

Figure 11. 15 Configure More Settings

4. Click the **Apply** button to save and exit the interface.

11.2.6 Configuring HTTPS Port

Purpose:

HTTPS provides authentication of the web site and associated web server that one is communicating with, which protects against Man-in-the-middle attacks. Perform the following steps to set the port number of https.

Example:

If you set the port number as 443 and the IP address is 192.0.0.64, you may access the device by inputting `https://192.0.0.64:443` via the web browser.



The HTTPS port can be only configured through the web browser.

Steps:

1. Open web browser, input the IP address of device, and the web server will select the language automatically according to the system language and maximize the web browser.
2. Input the correct user name and password, and click **Login** button to log in the device.
3. Enter the HTTPS settings interface.
Configuration > Remote Configuration > Network Settings > HTTPS
4. Create the self-signed certificate or authorized certificate.

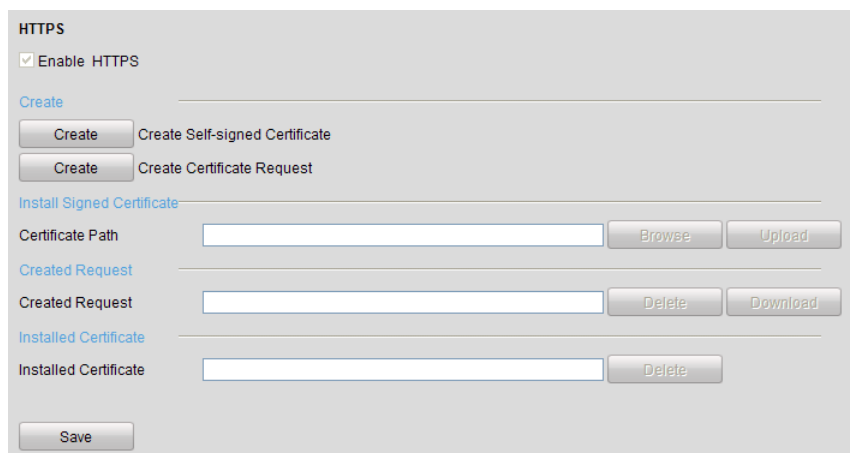

Figure 11. 16 HTTPS Settings

OPTION 1: Create the self-signed certificate

- 1) Click the **Create** button to create the following dialog box.

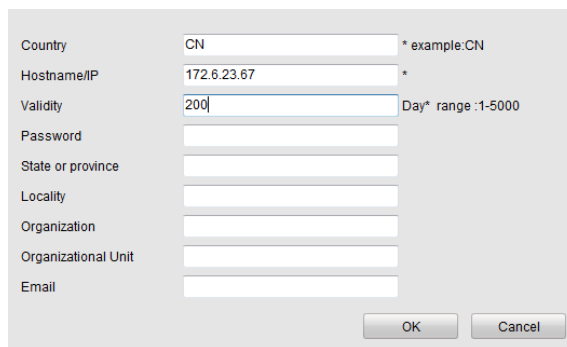

Figure 11. 17 Create Self-signed Certificate

- 2) Enter the country, host name/IP, validity and other information.
- 3) Click **OK** to save the settings.

OPTION 2: Create the authorized certificate

- 1) Click the **Create** button to create the certificate request.
 - 2) Download the certificate request and submit it to the trusted certificate authority for signature.
 - 3) After receiving the signed valid certificate, import the certificate to the device.
5. There will be the certificate information after you successfully create and install the certificate.

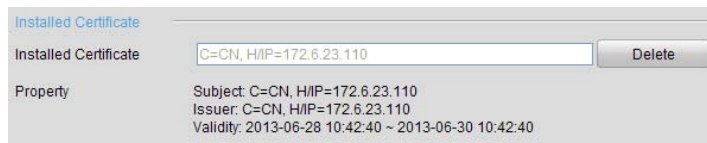

Figure 11. 18 Installed Certificate Property

6. Check the checkbox to enable the HTTPS function.
7. Click the **Save** button to save the settings.

11.2.7 Configuring Email

Purpose:

The system can be configured to send an Email notification to all designated users if an alarm event is detected, etc., an alarm or motion event is detected or the administrator password is changed.

Before configuring the Email settings, the NVR must be connected to a local area network (LAN) that maintains an SMTP mail server. The network must also be connected to either an intranet or the Internet depending on the location of the e-mail accounts to which you want to send notification.

Steps:

1. Enter the Network Settings interface.
Menu >Configuration> Network
2. Set the IPv4 Address, IPv4 Subnet Mask, IPv4 Gateway and the Preferred DNS Server in the Network Settings menu, as shown in Figure 11. 19.

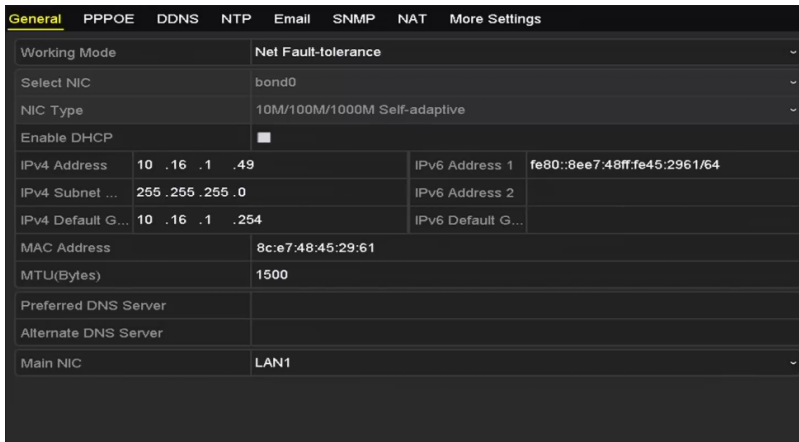

Figure 11. 19 Network Settings Interface

3. Click **Apply** to save the settings.
4. Select the Email tab to enter the Email Settings interface.

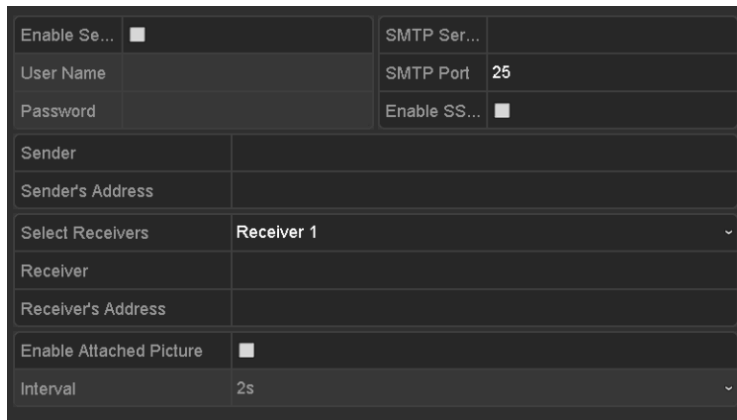

Figure 11. 20 Email Settings Interface

5. Configure the following Email settings:
Enable Server Authentication (optional): Check the checkbox to enable the server authentication feature.

User Name: The user name of sender’s account registered on the SMTP server.

Password: The password of sender’s account registered on the SMTP server.

SMTP Server: The SMTP Server IP address or host name (e.g., smtp.263xmail.com).

SMTP Port: The SMTP port. The default TCP/IP port used for SMTP is 25.

Enable SSL/TLS (optional): Click the checkbox to enable SSL/TLS if required by the SMTP server.

Sender: The name of sender.

Sender’s Address: The Email address of sender.

Select Receivers: Select the receiver. Up to 3 receivers can be configured.

Receiver: The name of user to be notified.

Receiver’s Address: The Email address of user to be notified.

Enable Attached Picture: Check the checkbox of **Enable Attached Picture** if you want to send email with attached alarm images. The interval is the time of two adjacent alarm images. You can also set SMTP port and enable SSL here.

Interval: The interval refers to the time between two actions of sending attached pictures.

6. Click **Apply** button to save the Email settings.
7. You can click **Test** button to test whether your Email settings work.

11.2.8 Configuring NAT

Purpose:

Two ways are provided for port mapping to realize the remote access via the cross-segment network, UPnP™ and manual mapping.

- **UPnP™**

Universal Plug and Play (UPnP™) can permit the device seamlessly discover the presence of other network devices on the network and establish functional network services for data sharing, communications, etc. You can use the UPnP™ function to enable the fast connection of the device to the WAN via a router without port mapping.

Before you start:

If you want to enable the UPnP™ function of the device, you must enable the UPnP™ function of the router to which your device is connected. When the network working mode of the device is set as multi-address, the Default Route of the device should be in the same network segment as that of the LAN IP address of the router.

Steps:

1. Enter the Network Settings interface.
Menu > Configuration > Network
2. Select the **NAT** tab to enter the port mapping interface.

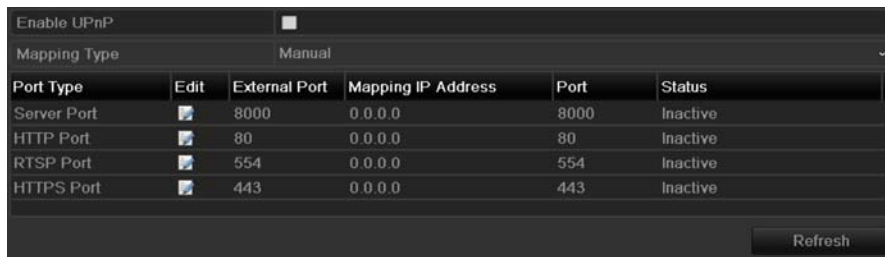

Figure 11. 21 UPnP™ Settings Interface

3. Check checkbox to enable UPnP™.

- Select the Mapping Type as Manual or Auto in the drop-down list.

OPTION 1: Auto

If you select Auto, the Port Mapping items are read-only, and the external ports are set by the router automatically.

Steps:

- Select **Auto** in the drop-down list of Mapping Type.
- Click **Apply** button to save the settings.
- You can click **Refresh** button to get the latest status of the port mapping.

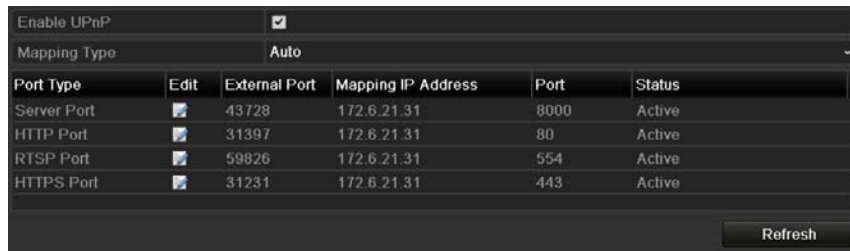

Figure 11. 22 UPnP™ Settings Finished-Auto

OPTION 2: Manual

If you select Manual as the mapping type, you can edit the external port on your demand by clicking to activate the External Port Settings dialog box.

Steps:

- Select **Manual** in the drop-down list of Mapping Type.
- Click to activate the External Port Settings dialog box. Configure the external port No. for server port, http port, RTSP port and https port respectively.



- You can use the default port No., or change it according to actual requirements.
- External Port indicates the port No. for port mapping in the router.
- The value of the RTSP port No. should be 554 or between 1024 and 65535, while the value of the other ports should be between 1 and 65535 and the value must be different from each other. If multiple devices are configured for the UPnP™ settings under the same router, the value of the port No. for each device should be unique.



Figure 11. 23 External Port Settings Dialog Box

- Click **Apply** button to save the settings.
- You can click **Refresh** button to get the latest status of the port mapping.

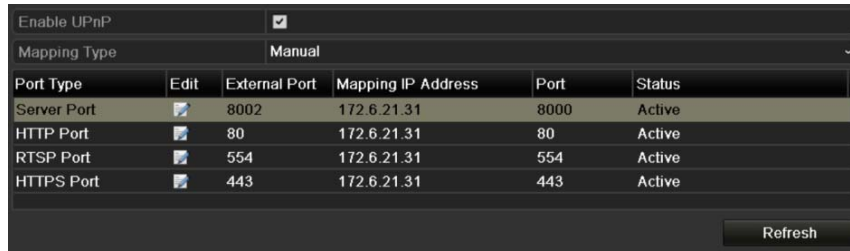

The screenshot shows the UPnP settings interface with the 'Enable UPnP' checkbox checked and 'Mapping Type' set to 'Manual'. A table lists the port mappings:

Port Type	Edit	External Port	Mapping IP Address	Port	Status
Server Port		8002	172.6.21.31	8000	Active
HTTP Port		80	172.6.21.31	80	Active
RTSP Port		554	172.6.21.31	554	Active
HTTPS Port		443	172.6.21.31	443	Active

A 'Refresh' button is located at the bottom right of the table.

Figure 11. 24 UPnP™ Settings Finished-Manual

● Manual Mapping

If your router does not support the UPnP™ function, perform the following steps to map the port manually in an easy way.

Before you start:

Make sure the router support the configuration of internal port and external port in the interface of Forwarding.

Steps:

1. Enter the Network Settings interface.
Menu > Configuration > Network
2. Select the **NAT** tab to enter the port mapping interface.
3. Leave the Enable UPnP checkbox unchecked.
4. Click to activate the External Port Settings dialog box. Configure the external port No. for server port, http port, RTSP port and https port respectively.



The value of the RTSP port No. should be 554 or between 1024 and 65535, while the value of the other ports should be between 1 and 65535 and the value must be different from each other. If multiple devices are configured for the UPnP™ settings under the same router, the value of the port No. for each device should be unique.

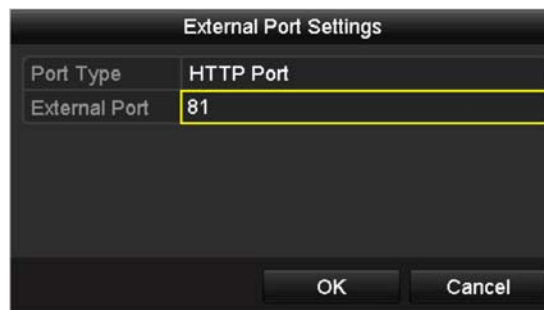

The dialog box is titled 'External Port Settings' and contains the following fields:

Port Type	HTTP Port
External Port	81

At the bottom, there are 'OK' and 'Cancel' buttons.

Figure 11. 25 External Port Settings Dialog Box

5. Click **OK** to save the setting for the current port and return to the upper-level menu.
6. Click **Apply** button to save the settings.
7. Enter the virtual server setting page of router; fill in the blank of Internal Source Port with the internal port value, the blank of External Source Port with the external port value, and other required contents.



Each item should be corresponding with the device port, including server port, http port, RTSP port and https port.

External Delete	External Source Port	Protocol	Internal Source IP	Internal Source Port	Application
<input type="checkbox"/>	81	TCP	192.168.251.101	80	HTTP

Figure 11. 26 Setting Virtual Server Item



The above virtual server setting interface is for reference only, it may be different due to different router manufactures. Please contact the manufacture of router if you have any problems with setting virtual server.

11.2.9 Configuring Virtual Host

Purpose:

You can directly get access to the IP camera management interface after enabling this function.



The Virtual host function can be only configured through the web browser.

Steps:

1. Enter the Advanced settings interface, as shown in the Figure 11. 27.

Configuration > Network > Advanced Settings > Other

Advanced

Alarm Host IP

Alarm Host Port

Multicast Address

Enable Virtual Host

Figure 11. 27 Advanced Settings Interface

2. Check the checkbox of the **Enable Virtual Host**.
3. Click the **Save** button to save the setting.
4. Enter the IP camera management interface of NVR. The Connect column appears on the right-most side of the camera list, as shown in the Figure 11. 28.

Configuration > Remote Configuration > Camera Management > IP Camera

Channel No.	IP Camera Address	Channel No.	Management Port	Status	Protocol	Connect
<input type="checkbox"/> D01	172.6.22.84	1	80	Online	ONVIF	http://172.6.22.84:80
<input type="checkbox"/> D02	172.6.23.123	1	8000	Offline(Network Abnormal)	HIKVISION	http://172.6.23.123:80
<input type="checkbox"/> D03	172.6.10.13	1	8000	Online	HIKVISION	http://172.6.10.13:80
<input type="checkbox"/> D04	172.6.23.2	1	8000	Online	HIKVISION	http://172.6.23.2:80

Figure 11. 28 Connect to IP Camera

5. Click the link and the page of IP camera management appears.

11.3 Checking Network Traffic

Purpose:

You can check the network traffic to obtain real-time information of NVR such as linking status, MTU, sending/receiving rate, etc.

Steps:

1. Enter the Network Traffic interface.
Menu > Maintenance > Net Detect



Figure 11. 29 Network Traffic Interface

2. You can view the sending rate and receiving rate information on the interface. The traffic data is refreshed every 1 second.

11.4 Configuring Network Detection

Purpose:

You can obtain network connecting status of NVR through the network detection function, including network delay, packet loss, etc.

11.4.1 Testing Network Delay and Packet Loss

Steps:

1. Enter the Network Traffic interface.
Menu >Maintenance>Net Detect
2. Click the **Network Detection** tab to enter the Network Detection menu, as shown in Figure 11. 30.

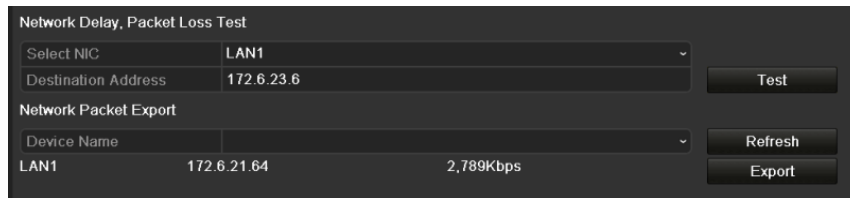

Figure 11. 30 Network Detection Interface

3. Enter the destination address in the text field of **Destination Address**.
4. Click **Test** button to start testing network delay and packet loss. The testing result pops up on the window. If the testing is failed, the error message box will pop up as well. Refer to Figure 11. 31.

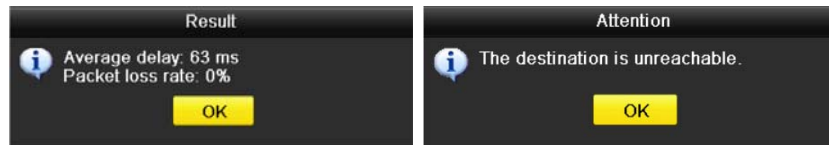

Figure 11. 31 Testing Result of Network Delay and Packet Loss

11.4.2 Exporting Network Packet

Purpose:

By connecting the NVR to network, the captured network data packet can be exported to USB-flash disk, SATA/eSATA, DVD-R/W and other local backup devices.

Steps:

1. Enter the Network Traffic interface.
Menu >Maintenance>Net Detect
2. Click the **Network Detection** tab to enter the Network Detection interface.
3. Select the backup device from the dropdown list of Device Name, as shown in Figure 11. 32.



Click **Refresh** button if the connected local backup device cannot be displayed. When it fails to detect the backup device, please check whether it is compatible with the NVR. You can format the backup device if the format is incorrect.

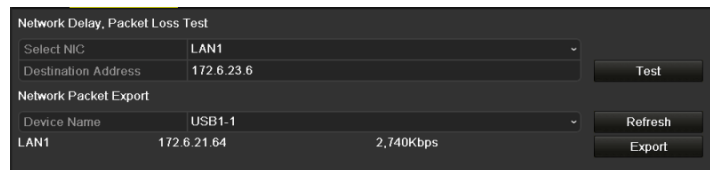

Figure 11. 32 Export Network Packet

4. Click **Export** button to start exporting.
5. After the exporting is complete, click **OK** to finish the packet export, as shown in Figure 11. 33.

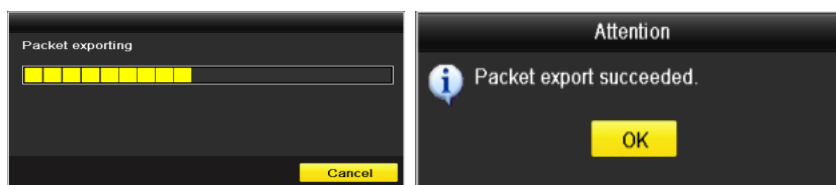

Figure 11. 33 Packet Export Attention



Up to 1M data can be exported each time.

11.4.3 Checking the Network Status

Purpose:

You can also check the network status and quick set the network parameters in this interface.

Steps:

- Click the **Status** button on the lower- right corner of the page.

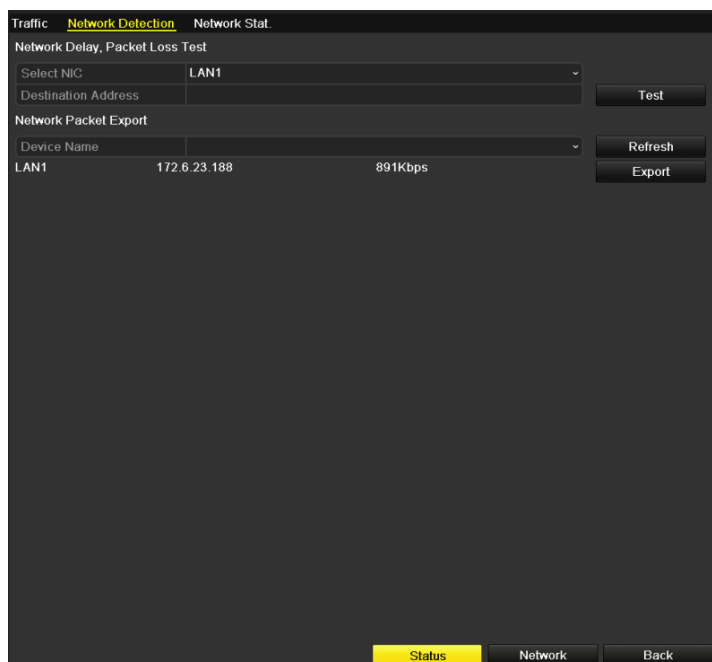

Figure 11. 34 Network Status Checking

If the network is normal the following message box pops out.

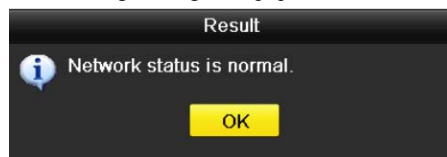

Figure 11. 35 Network Status Checking Result

If the message box pops out with other information instead of this one, you can click **Network** button to show the quick setting interface of the network parameters.

11.4.4 Checking Network Statistics

Purpose:

You can check the network status to obtain the real-time information of NVR.

Steps:

1. Enter the Network Detection interface.
Menu>Maintenance>Net Detect
2. Choose the **Network Stat.** tab.

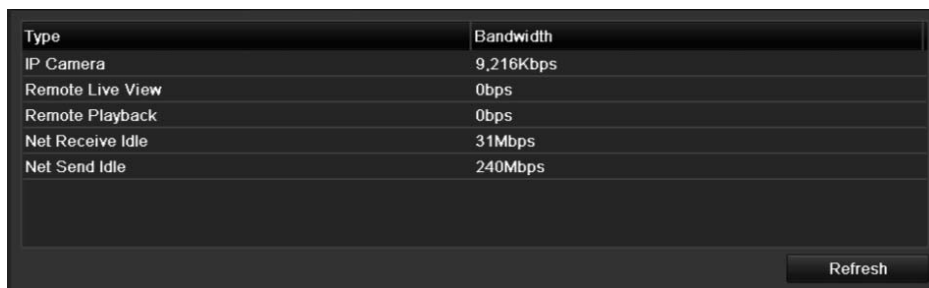

Type	Bandwidth
IP Camera	9,216Kbps
Remote Live View	0bps
Remote Playback	0bps
Net Receive Idle	31Mbps
Net Send Idle	240Mbps

Refresh

Figure 11. 36 Network Stat. Interface

3. Check the bandwidth of IP Camera, bandwidth of Remote Live View, bandwidth of Remote Playback, bandwidth of Net Receive Idle and bandwidth of Net Send Idle.
4. You can click **Refresh** to get the newest status.

Chapter 12 HDD Management

12.1 Initializing HDDs

Purpose:

A newly installed hard disk drive (HDD) must be initialized before it can be used with your NVR.



A message box pops up when the NVR starts up if there exists any uninitialized HDD.



Figure 12. 1 Message Box of Uninitialized HDD

Click **Yes** button to initialize it immediately or you can perform the following steps to initialize the HDD.

Steps:

1. Enter the HDD Information interface.

Menu > HDD> General

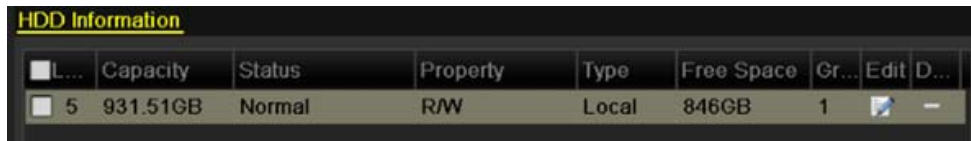

Figure 12. 2 HDD Information Interface

2. Select HDD to be initialized.
3. Click the **Init** button.

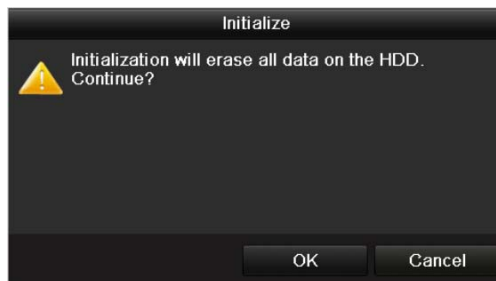

Figure 12. 3 Confirm Initialization

4. Select the **OK** button to start initialization.

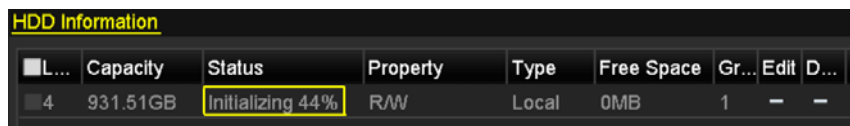
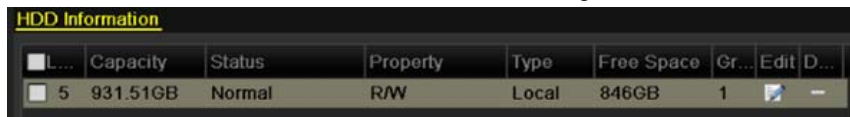

Figure 12. 4 Status changes to Initializing

5. After the HDD has been initialized, the status of the HDD will change from *Uninitialized* to *Normal*.



The screenshot shows a table titled "HDD Information" with the following data:

<input type="checkbox"/> L...	Capacity	Status	Property	Type	Free Space	Gr...	Edit D...
<input type="checkbox"/> 5	931.51GB	Normal	RW	Local	846GB	1	—

Figure 12. 5 HDD Status Changes to Normal



Initializing the HDD will erase all data on it.

12.2 Managing Network HDD

Purpose:

You can add the allocated NAS or disk of IP SAN to NVR, and use it as network HDD. Up to 8 network disks can be added.

Steps:

1. Enter the HDD Information interface.

Menu > HDD>General

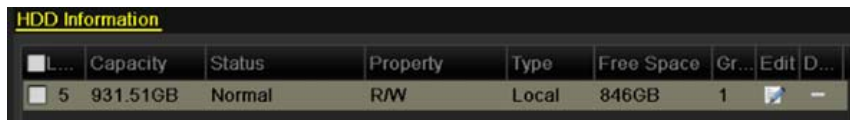

L...	Capacity	Status	Property	Type	Free Space	Gr...	Edit D...
5	931.51GB	Normal	RW	Local	846GB	1	-

Figure 12. 6 HDD Information Interface

2. Click the **Add** button to enter the Add NetHDD interface, as shown in Figure 12. 7.

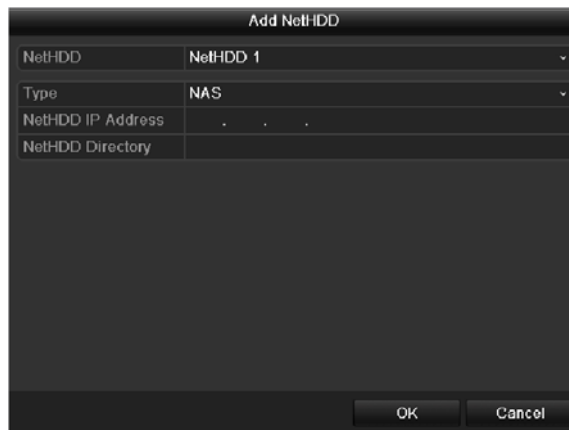

Add NetHDD	
NetHDD	NetHDD 1
Type	NAS
NetHDD IP Address	.
NetHDD Directory	
<input type="button" value="OK"/> <input type="button" value="Cancel"/>	

Figure 12. 7 HDD Information Interface

3. Add the allocated NetHDD.
4. Select the type to NAS or IP SAN.
5. Configure the NAS or IP SAN settings.
 - **Add NAS disk:**
 - 1) Enter the NetHDD IP address in the text field.
 - 2) Click the **Search** button to search the available NAS disks.
 - 3) Select the NAS disk from the list shown below.
 - Or you can just manually enter the directory in the text field of NetHDD Directory.
 - 4) Click the **OK** button to add the configured NAS disk.



Figure 12. 8 Add NAS Disk

• **Add IP SAN:**

- 1) Enter the NetHDD IP address in the text field.
- 2) Click the **Search** button to search the available IP SAN disks.
- 3) Select the IP SAN disk from the list shown below.
- 4) Click the **OK** button to add the selected IP SAN disk.



Up to 1 IP SAN disk can be added.

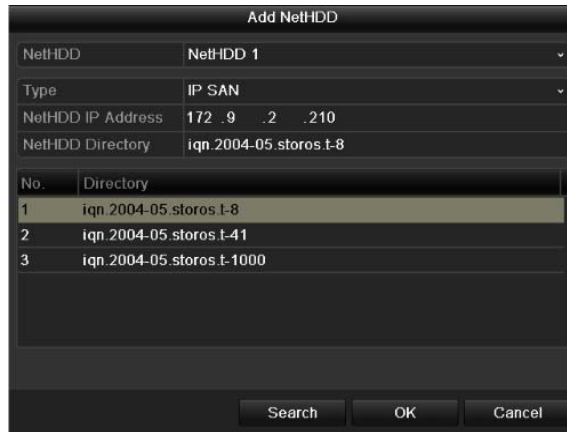

Figure 12. 9 Add IP SAN Disk

6. After having successfully added the NAS or IP SAN disk, return to the HDD Information menu. The added NetHDD will be displayed in the list.



If the added NetHDD is uninitialized, please select it and click the **Init** button for initialization.

Label	Capacity	Status	Property	Type	Free Space	Gro...	Edit	Del...
3	931.51GB	Normal	R/W	Local	890GB	1		-
4	931.51GB	Normal	R/W	Local	867GB	1		-
17	79,968MB	Normal	R/W	NAS	79,872MB	1		

Figure 12. 10 Initialize Added NetHDD

12.3 Managing HDD Group

12.3.1 Setting HDD Groups

Purpose:

Multiple HDDs can be managed in groups. Video from specified channels can be recorded onto a particular HDD group through HDD settings.

Steps:

1. Enter the Storage Mode interface.
Menu > HDD > Advanced > Storage Mode
2. Set the **Mode** to Group, as shown in Figure 12. 11.

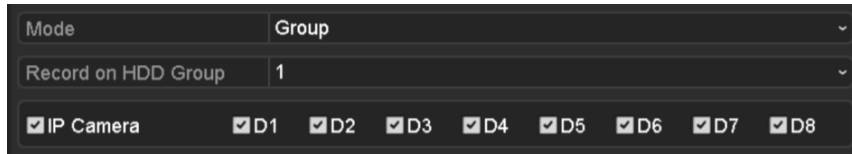

Figure 12. 11 Storage Mode Interface

3. Click the **Apply** button and the following Attention box will pop up.

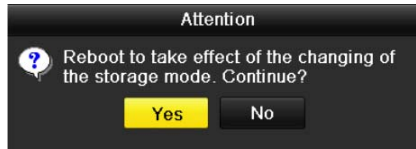

Figure 12. 12 Attention for Reboot

4. Click the **Yes** button to reboot the device to activate the changes.
5. After reboot of device, enter the HDD Information interface.
Menu > HDD> General
6. Select HDD from the list and click  icon to enter the Local HDD Settings interface, as shown in Figure 12. 13.



Figure 12. 13 Local HDD Settings Interface

7. Select the Group number for the current HDD.



The default group No. for each HDD is 1.

8. Click the **OK** button to confirm the settings.



Figure 12. 14 Confirm HDD Group Settings

9. In the pop-up Attention box, click the **Yes** button to finish the settings.

12.3.2 Setting HDD Property

Purpose:

The HDD property can be set to redundancy, read-only or read/write (R/W). Before setting the HDD property, please set the storage mode to Group (refer to step1-4 of Chapter Setting HDD Groups).

A HDD can be set to read-only to prevent important recorded files from being overwritten when the HDD becomes full in overwrite recording mode.

When the HDD property is set to redundancy, the video can be recorded both onto the redundancy HDD and the R/W HDD simultaneously so as to ensure high security and reliability of video data.

Steps:

1. Enter the HDD Information interface.
Menu > HDD > General
2. Select HDD from the list and click the icon to enter the Local HDD Settings interface, as shown in Figure 12. 15.



Figure 12. 15 Set HDD Property

3. Set the HDD property to R/W, Read-only or Redundancy.
4. Click the **OK** button to save the settings and exit the interface.
5. In the HDD Information menu, the HDD property will be displayed in the list.



At least 2 hard disks must be installed on your NVR when you want to set a HDD to Redundancy, and there is one HDD with R/W property.

12.4 Configuring Quota Mode

Purpose:

Each camera can be configured with allocated quota for the storage of recorded files.

Steps:

1. Enter the Storage Mode interface.
Menu > HDD > Advanced
2. Set the **Mode** to Quota, as shown in Figure 12. 16.



The NVR must be rebooted to enable the changes to take effect.

Mode	Quota
Camera	IP Camera 1
Used Record Capacity	8,192MB
Used Picture Capacity	1,024MB
HDD Capacity (GB)	931
Max. Record Capacity (GB)	80
Max. Picture Capacity (GB)	100
▲ Free Quota Space 751 GB	

Figure 12. 16 Storage Mode Settings Interface

3. Select a camera for which you want to configure quota.
4. Enter the storage capacity in the text fields of **Max. Record Capacity (GB)** and **Max. Picture Capacity (GB)**, as shown in Figure 12. 17.

Mode	Quota
Camera	IP Camera 1
Used Record Capacity	8,192MB
Used Picture Capacity	1,024MB
HDD Capacity (GB)	931
Max. Record Capacity (GB)	80
Max. Picture Capacity (GB)	100
▲ Free Quota Space 751 GB	

1	2	3
4	5	6
7	8	9
-	0	←
↵		Enter ESC

Figure 12. 17 Configure Record/Picture Quota

5. You can copy the quota settings of the current camera to other cameras if required. Click the **Copy** button to enter the Copy Camera menu, as shown in Figure 12. 18.



Figure 12. 18 Copy Settings to Other Camera(s)

6. Select the camera (s) to be configured with the same quota settings. You can also click the checkbox of IP Camera to select all cameras.
7. Click the **OK** button to finish the Copy settings and back to the Storage Mode interface.
8. Click the **Apply** button to apply the settings.



If the quota capacity is set to 0, then all cameras will use the total capacity of HDD for record.

12.5 Configuring Disk Clone

Purpose:

If the S.M.A.R.T. detection result declares the HDD is abnormal, you can choose to clone all the data on the HDD to an inserted eSATA disk manually. Refer to *Chapter HDD Detection* for details of S.M.A.R.T detection.

Before you start:

An eSATA disk should be connected to the device.

Steps:

1. Enter the HDD Advanced Setting interface:
Menu > HDD > Advanced
2. Click the **Disk Clone** tab to enter the disk clone configuring interface.

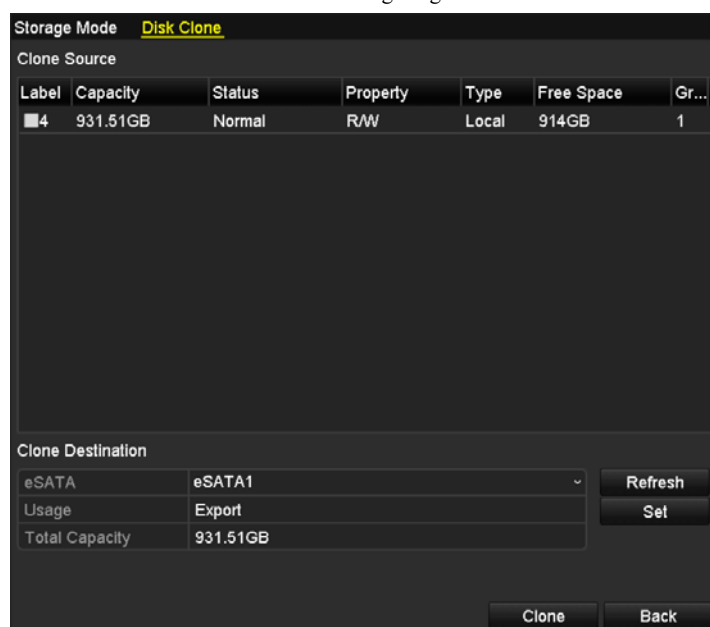

Figure 12. 19 Disk Clone Configuration Interface

3. Make sure the usage of the eSATA disk is set as Export.
If not, click the **Set** button to set it. Choose Export and click the **OK** button.



Figure 12. 20 Setting eSATA Usage



The capacity of destination disk must be the same as that of the clone source disk.

4. Check the checkbox of the HDD to be cloned in the Clone Source list.

5. Click the **Clone** button and a message box pops up.

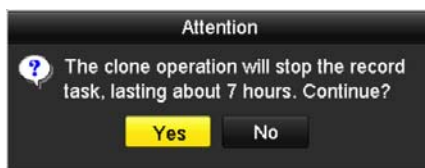

Figure 12. 21 Message Box for Disk Clone

6. Click the **Yes** button to continue.
You can check the clone progress in the HDD status.

Label	Capacity	Status	Property	Type	Free Space	Gr...
4	931.51GB	Cloning 01%	R/W	Local	0MB	1

Figure 12. 22 Check Disk Clone Progress

12.6 Checking HDD Status

Purpose:

You may check the status of the installed HDDs on NVR so as to take immediate check and maintenance in case of HDD failure.

Checking HDD Status in HDD Information Interface

Steps:

1. Enter the HDD Information interface.
Menu > HDD>General
2. Check the status of each HDD which is displayed on the list, as shown in Figure 12. 23.



Label	Capacity	Status	Property	Type	Free Space	Gro...	Edit	Del...
4	931.51GB	Normal	R/W	Local	921GB	1		—
18	10.048MB	Uninitialized	R/W	NAS	0MB	1		
25	931.51GB	Normal	R/W	eSATA	894GB	1		

Total Capacity	1,872GB
Free Space	1,815GB

Figure 12. 23 View HDD Status (1)



If the status of HDD is *Normal* or *Sleeping*, it works normally. If the status is *Uninitialized* or *Abnormal*, please initialize the HDD before use. And if the HDD initialization is failed, please replace it with a new one.

Checking HDD Status in HDD Information Interface

Steps:

1. Enter the System Information interface.
Menu > Maintenance > System Info
2. Click the **HDD** tab to view the status of each HDD displayed on the list, as shown in Figure 12. 24.

The screenshot displays the 'HDD' status page. At the top, there are navigation tabs: 'Device Info', 'Camera', 'Record', 'Alarm', 'Network', and 'HDD'. Below the tabs is a table with the following data:

Label	Status	Capacity	Free Space	Property	Type	Group
5	Normal	931GB	931GB	R/W	Local	1
6	Sleeping	931GB	931GB	Redundancy	Local	1
17	Normal	40,000MB	22,528MB	R/W	IP SAN	1

Below the table, there is a summary section:

Total Capacity	1,902GB
Free Space	1,884GB

A yellow 'Back' button is located at the bottom right of the interface.

Figure 12. 24 View HDD Status (2)

12.7 HDD Detection

Purpose:

The device provides the HDD detection function such as the adopting of the S.M.A.R.T. and the Bad Sector Detection technique. The S.M.A.R.T. (Self-Monitoring, Analysis and Reporting Technology) is a monitoring system for HDD to detect and report on various indicators of reliability in the hopes of anticipating failures.

S.M.A.R.T. Settings

Steps:

1. Enter the S.M.A.R.T Settings interface.
Menu > Maintenance > HDD Detect
2. Select the HDD to view its S.M.A.R.T information list, as shown in Figure 12. 25.

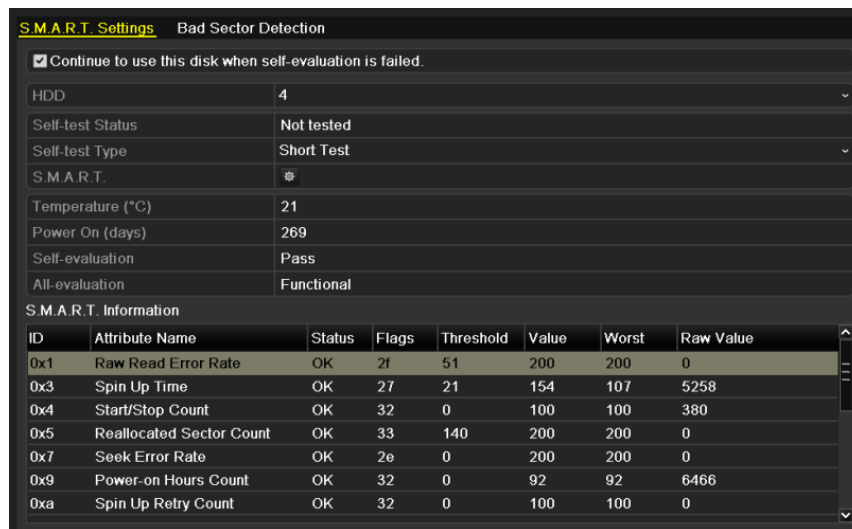

Figure 12. 25 S.M.A.R.T Settings Interface

The related information of the S.M.A.R.T. is shown on the interface.

You can choose the self-test types as Short Test, Expanded Test or the Conveyance Test.

Click the start button to start the S.M.A.R.T. HDD self-evaluation.



If you want to use the HDD even when the S.M.A.R.T. checking is failed, you can check the checkbox of the **Continue to use the disk when self-evaluation is failed** item.

Bad Sector Detection

Steps:

1. Click the Bad Sector Detection tab.
2. Select the HDD No. in the dropdown list you want to configure, and choose All Detection or Key Area Detection as the detection type.
3. Click the **Detect** button to start the detection.

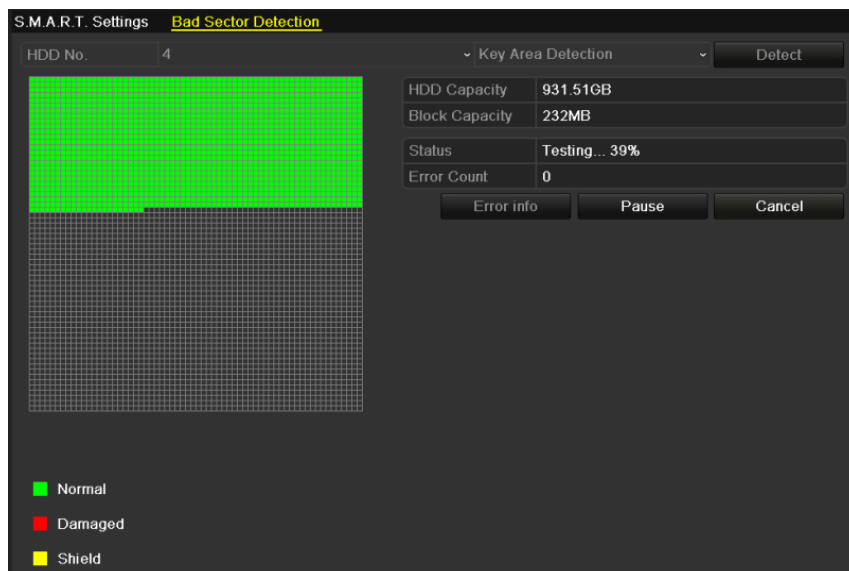

Figure 12. 26 Bad Sector Detection

And you can click **Error info** button to see the detailed damage information.

And you can also pause/resume or cancel the detection.

12.8 Configuring HDD Error Alarms

Purpose:

You can configure the HDD error alarms when the HDD status is *Uninitialized* or *Abnormal*.

Steps:

1. Enter the Exception interface.
Menu > Configuration > Exceptions
2. Select the Exception Type to **HDD Error** from the dropdown list.
3. Click the checkbox(s) below to select the HDD error alarm type (s), as shown in Figure 12. 27.



The alarm type can be selected to: Audible Warning, Notify Surveillance Center, Send Email and Trigger Alarm Output. Please refer to *Chapter Setting Alarm Response Actions*.

Exception Type	HDD Error
Audible Warning	<input type="checkbox"/>
Notify Surveillance Center	<input type="checkbox"/>
Send Email	<input type="checkbox"/>
Trigger Alarm Output	<input checked="" type="checkbox"/>
<input type="checkbox"/> Alarm Output No.	Alarm Name
<input type="checkbox"/> Local->1	
<input type="checkbox"/> Local->2	
<input type="checkbox"/> Local->3	
<input type="checkbox"/> Local->4	
<input checked="" type="checkbox"/> 172.6.23.105:8000->1	

Figure 12. 27 Configure HDD Error Alarm

4. When the Trigger Alarm Output is selected, you can also select the alarm output to be triggered from the list below.
5. Click the **Apply** button to save the settings

Chapter 13 Camera Settings

13.1 Configuring OSD Settings

Purpose:

You can configure the OSD (On-screen Display) settings for the camera, including date /time, camera name, etc.

Steps:

1. Enter the OSD Configuration interface.
Menu > Camera > OSD
2. Select the camera to configure OSD settings.
3. Edit the Camera Name in the text field.
4. Configure the Display Name, Display Date and Display Week by clicking the checkbox.
5. Select the Date Format, Time Format and Display Mode.

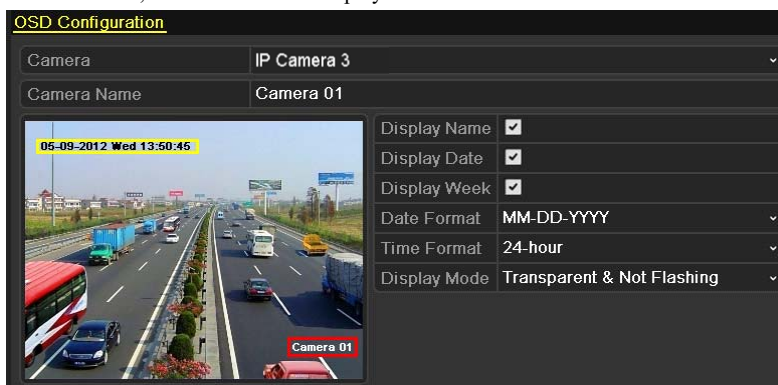

Figure 13. 1 OSD Configuration Interface

6. You can use the mouse to click and drag the text frame on the preview window to adjust the OSD position.
7. Click the **Apply** button to apply the settings.

13.2 Configuring Privacy Mask

Purpose:

You are allowed to configure the four-sided privacy mask zones that cannot be viewed by the operator. The privacy mask can prevent certain surveillance areas to be viewed or recorded.

Steps:

1. Enter the Privacy Mask Settings interface.
Menu > Camera > Privacy Mask
2. Select the camera to set privacy mask.
3. Click the checkbox of **Enable Privacy Mask** to enable this feature.

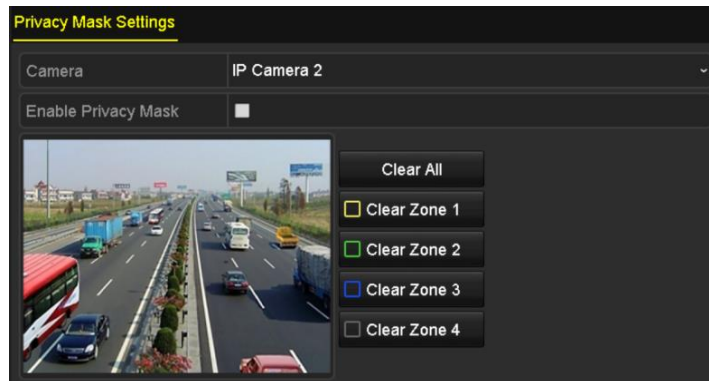

Figure 13. 2 Privacy Mask Settings Interface

4. Use the mouse to draw a zone on the window. The zones will be marked with different frame colors.



Up to 4 privacy masks zones can be configured and the size of each area can be adjusted.

5. The configured privacy mask zones on the window can be cleared by clicking the corresponding Clear Zone1-4 icons on the right side of the window, or click **Clear All** to clear all zones.

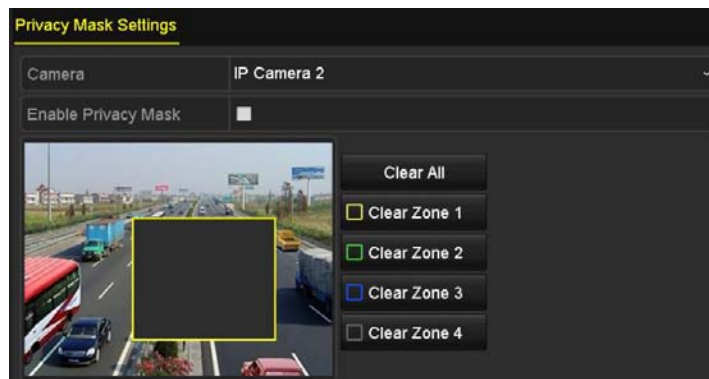

Figure 13. 3 Set Privacy Mask Area

6. Click the **Apply** button to save the settings.

13.3 Configuring Video Parameters

Purpose:

You can customize the image parameters including the brightness, contrast, saturation, image rotate and mirror for the live view and recording effect.

Steps:

1. Enter the Image Settings interface.

Menu > Camera > Image

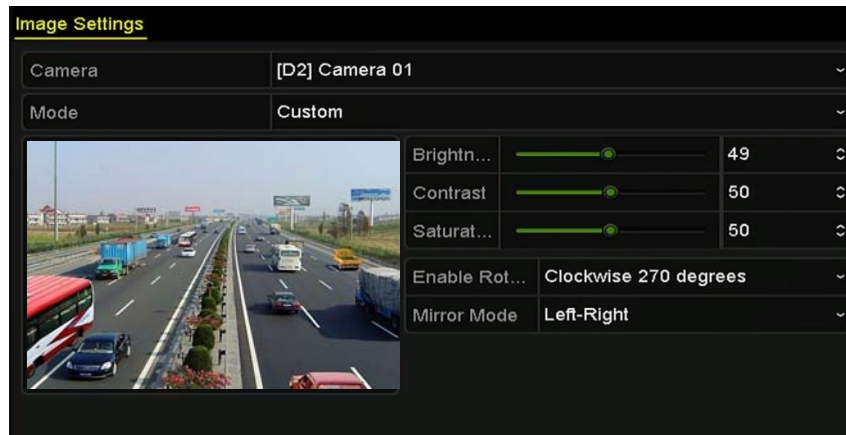

Figure 13. 4 Image Settings Interface

2. Select the camera to set image parameters.
3. Adjust the slider or click on the up/down arrow to set the value of the brightness, contrast or saturation.
4. Select the **Enable Rotate** function to Clockwise 270 degrees or OFF. When OFF is selected, the image is restored to original.
5. Select the **Mirror Mode** to Left-Right, Up-Down, Center or OFF. When OFF is selected, the image is restored to original.



- The Rotate and Mirror functions must be supported by the connected IP camera.
 - The image parameters adjustment can affect both the live view and the recording quality.
6. Click the **Apply** button to save the settings.

Chapter 14 NVR Management and Maintenance

14.1 Viewing System Information

Steps:

1. Enter the System Information interface.
Menu >Maintenance>System Info
2. You can click the **Device Info**, **Camera**, **Record**, **Alarm**, **Network** and **HDD** tabs to view the system information of the device.



Figure 14. 1 Device Information Interface



You can add the device to your mobile client software (iVMS-4500) via scanning the QR Code.

14.2 Searching & Exporting Log Files

Purpose:

The operation, alarm, exception and information of the NVR can be stored in log files, which can be viewed and exported at any time.

Steps:

1. Enter the Log Search interface.
Menu > Maintenance > Log Information

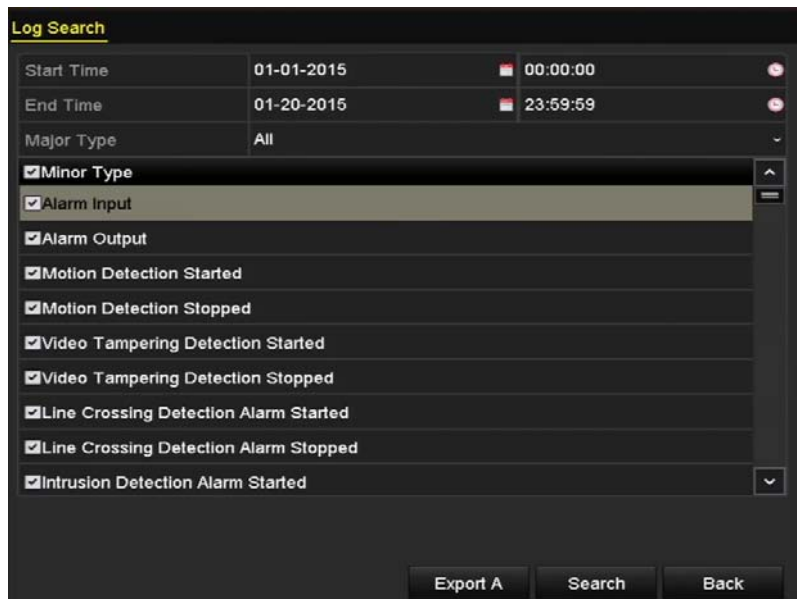

Figure 14. 2 Log Search Interface

2. Set the log search conditions to refine your search, including the Start Time, End Time, Major Type and Minor Type.
3. Click the **Search** button to start search log files.
4. The matched log files will be displayed on the list shown below.

No.	Major Type	Time	Minor Type	Parameter	Play	Details
1	Operation	01-14-2015 21:04:06	Abnormal Shutd...	N/A	—	✓
2	Operation	01-14-2015 21:04:08	Power On	N/A	—	✓
3	Exception	01-14-2015 21:04:08	Record Exception	N/A	⏸	✓
4	Operation	01-14-2015 21:11:44	Local Operation:...	N/A	—	✓
5	Operation	01-14-2015 21:39:45	Power On	N/A	—	✓
6	Exception	01-14-2015 21:39:47	Record Exception	N/A	⏸	✓
7	Operation	01-14-2015 21:44:05	Abnormal Shutd...	N/A	—	✓
8	Operation	01-14-2015 21:44:06	Power On	N/A	—	✓
9	Exception	01-14-2015 21:44:07	Record Exception	N/A	⏸	✓
10	Operation	01-14-2015 21:57:06	Abnormal Shutd...	N/A	—	✓

Total: 985 P: 1/10

Export Back

Figure 14. 3 Log Search Results



Up to 2000 log files can be displayed each time.

- You can click the button of each log or double click it to view its detailed information, as shown in Figure 14. 4. And you can also click the button to view the related video files if available.

Log Information	
Time	01-14-2015 21:57:06
Type	Operation--Power On
Local User	N/A
Host IP Address	N/A
Parameter Type	N/A
Camera No.	N/A
Description:	
Model: DS-96128N-H16	
Serial No.: DS-96128N-H161620141222CCRR201412224WCVU	
Firmware version: V3.2.0, Build 150109	
Encoding version: V1.0, Build 150108	

Previous Next OK

Figure 14. 4 Log Details

- If you want to export the log files, click the **Export** button to enter the Export menu, as shown in *Figure 14. 4 Log Details*.

You can also click **Export All** on the Log Search interface (Figure 15.2) to enter the Export interface (Figure 15.5), and all the system logs will be exported to the backup device.



Figure 14. 5 Export Log Files

7. Select the backup device from the dropdown list of **Device Name**.
8. Select the format of the log files to be exported. Up to 9 formats are selectable.
9. Click the **Export** to export the log files to the selected backup device.

You can click the **New Folder** button to create new folder in the backup device, or click the **Format** button to format the backup device before log export.



Please connect the backup device to NVR before operating log export.

14.3 Importing/Exporting IP Camera Info

Purpose:

The information of added IP camera can be generated into an excel file and exported to the local device for backup, including the IP address, manage port, password of admin, etc.. And the exported file can be edited on your PC, like adding or deleting the content, and copy the setting to other devices by importing the excel file to it.

Steps:

1. Enter the camera management interface.
Menu > Camera > IP Camera Import/Export
2. Click the IP Camera Import/Export tab, the content of detected plugged external device appears.
3. Click the **Export** button to export configuration files to the selected local backup device.
4. To import a configuration file, select the file from the selected backup device and click the **Import** button.
After the importing process is completed, you must reboot the NVR.

14.4 Importing/Exporting Configuration Files

Purpose:

The configuration files of the NVR can be exported to local device for backup; and the configuration files of one NVR can be imported to multiple NVR devices if they are to be configured with the same parameters.

Steps:

1. Enter the Import/Export Configuration File interface.

Menu > Maintenance > Import/Export



Figure 14. 6 Import/Export Config File

2. Click the **Export** button to export configuration files to the selected local backup device.
3. To import a configuration file, select the file from the selected backup device and click the **Import** button.
After the import process is completed, you must reboot the NVR.



After having finished the import of configuration files, the device will reboot automatically.

14.5 Upgrading System

Purpose:

The firmware on your NVR can be upgraded by local backup device or remote FTP server.

14.5.1 Upgrading by Local Backup Device

Steps:

1. Connect your NVR with a local backup device where the update firmware file is located.
2. Enter the Upgrade interface.
Menu >Maintenance>Upgrade
3. Click the **Local Upgrade** tab to enter the local upgrade menu, as shown in Figure 14. 7.

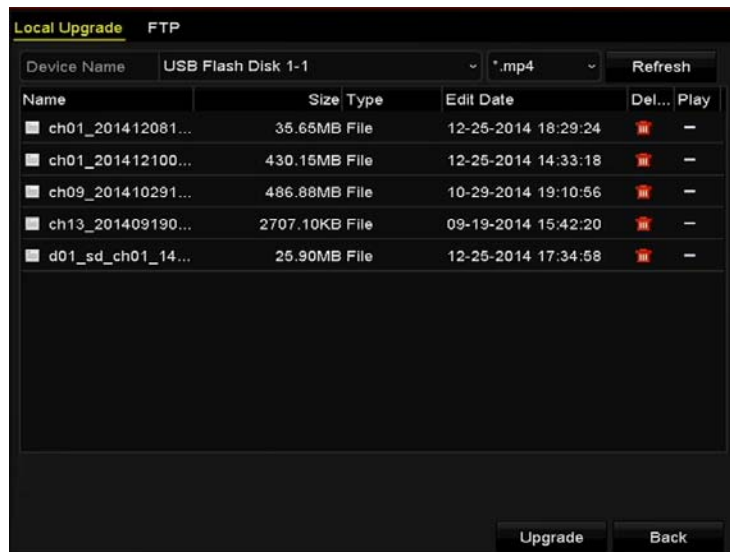

Figure 14. 7 Local Upgrade Interface

4. Select the update file from the backup device.
5. Click the **Upgrade** button to start upgrading.
6. After the upgrading is complete, reboot the NVR to activate the new firmware.

14.5.2 Upgrading by FTP

Before you start:

Ensure the network connection of the PC (running FTP server) and the device is valid and correct. Run the FTP server on the PC and copy the firmware into the corresponding directory of your PC.

Steps:

1. Enter the Upgrade interface.
Menu >Maintenance>Upgrade

2. Click the **FTP** tab to enter the local upgrade interface, as shown in Figure 14. 8.

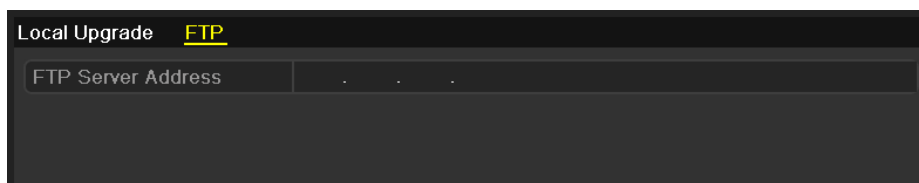

Figure 14. 8 FTP Upgrade Interface

3. Enter the FTP Server Address in the text field.
4. Click the **Upgrade** button to start upgrading.
5. After the upgrading is complete, reboot the NVR to activate the new firmware.

14.6 Restoring Default Settings

Steps:

1. Enter the Default interface.

Menu > Maintenance > Default

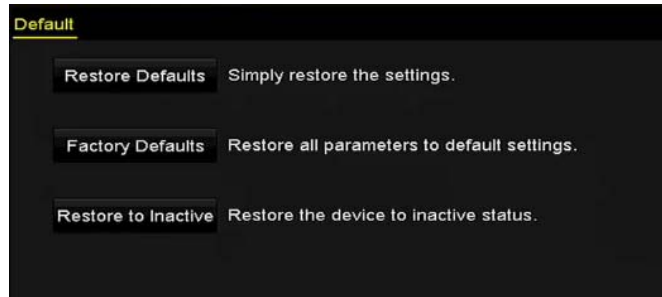

Figure 14. 9 Restore Defaults

2. Select the restoring type from the following three options.

Restore Defaults: Restore all parameters, except the network (including IP address, subnet mask, gateway, MTU, NIC working mode, default route, server port, etc.) and user account parameters, to the factory default settings.

Factory Defaults: Restore all parameters to the factory default settings.

Restore to Inactive: Restore the device to the inactive status.

3. Click the **OK** button to restore the default settings.



The device will reboot automatically after restoring to the default settings.

Chapter 15 Others

15.1 Configuring General Settings

Purpose:

You can configure the BNC output standard, VGA output resolution, mouse pointer speed through the Menu > Configuration > General interface.

Steps:

1. Enter the General Settings interface.
Menu > Configuration > General
2. Select the **General** tab.



Figure 15. 1 General Settings Interface

3. Configure the following settings:
 - **Language:** The default language used is *English*.
 - **Output Standard:** Select the output standard to NTSC or PAL, which must be the same with the video input standard.
 - **Resolution:** You can configure the VGA resolution and HDMI resolution respectively. And up to 4K (3840 × 2160) resolution is selectable for the HDMI output.
 - **Time Zone:** Select the time zone.
 - **Date Format:** Select the date format.
 - **System Date:** Select the system date.
 - **System Time:** Select the system time.
 - **Mouse Pointer Speed:** Set the speed of mouse pointer; 4 levels are configurable.
 - **Enable Wizard:** Enable/disable the Wizard when the device starts up.
 - **Enable Password:** Enable/disable the use of the login password.
4. Click the **Apply** button to save the settings.

15.2 Configuring DST Settings

Steps:

1. Enter the General Settings interface.
Menu > Configuration > General
2. Choose **DST Settings** tab.

General	DST Settings	More Settings
<input type="checkbox"/> Auto DST Adjustment		
<input checked="" type="checkbox"/> Enable DST		
From	Apr	1st Sun 2 :00
To	Oct	last Sun 2 :00
DST Bias	60 Minutes	

Figure 15. 2 DST Settings Interface

You can check the checkbox before the Auto DST Adjustment item.

Or you can manually check the Enable DST checkbox, and then you choose the date of the DST period.

15.3 Configuring More Settings

Steps:

1. Enter the General Settings interface.
Menu > Configuration > General
2. Click the **More Settings** tab to enter the More Settings interface.

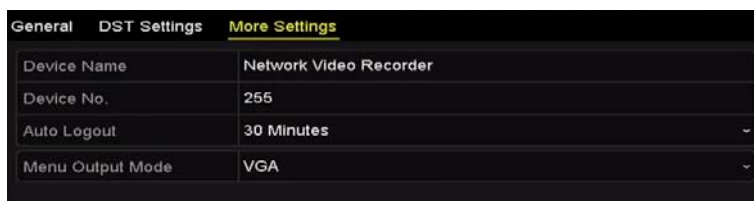

Figure 15. 3 More Settings Interface

3. Configure the following settings:
 - **Device Name:** Edit the name of NVR.
 - **Device No.:** Edit the serial number of NVR. The Device No. can be set in the range of 1~255, and the default No. is 255. The number is used for the remote and keyboard control.
 - **Auto Logout:** Set timeout time for menu inactivity. E.g., when the timeout time is set to *5 Minutes*, then the system will exit from the current operation menu to live view screen after 5 minutes of menu inactivity.
 - **Menu Output Mode:** You can choose the menu display on different video output.
You can select the menu output mode to **VGA**, **HDMI** or **Auto**. When the **Auto** option is selected and both HDMI and VGA outputs are connected, the device will detect and set the HDMI as the menu output.
4. Click the **Apply** button to save the settings.

15.4 Managing User Accounts

Purpose:

There is a default account in the NVR: *Administrator*. The *Administrator* user name is *admin* and the password is set when you start the device for the first time. The *Administrator* has the permission to add and delete user and configure user parameters.

15.4.1 Adding a User

Steps:

1. Enter the User Management interface.

Menu > Configuration > User

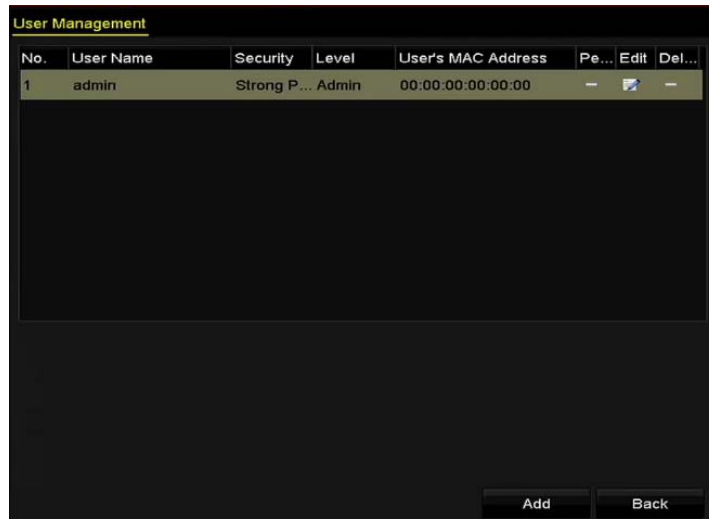

Figure 15. 4 User Management Interface

2. Click the **Add** button to enter the Add User interface.

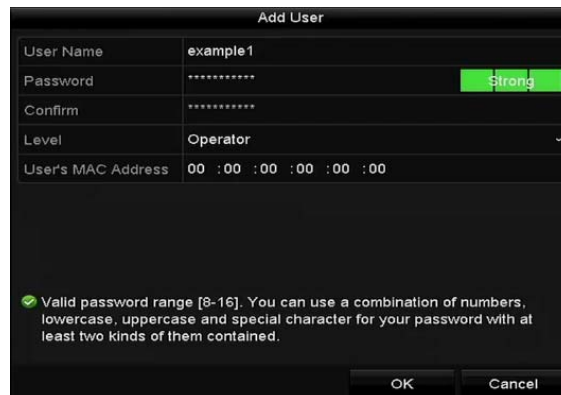

Figure 15. 5 Add User Menu

3. Enter the information for new user, including **User Name**, **Password**, **Confirm**, **Level** and **User's MAC Address**.

Password: Set the password for the user account.

! STRONG PASSWORD RECOMMENDED—We highly recommend you create a strong password of your own choosing (Using a minimum of 8 characters, including at least three of the following categories: upper case letters, lower case letters, numbers, and special characters.) in order to increase the security of your product. And we recommend you reset your password regularly, especially in the high security system, resetting the password monthly or weekly can better protect your product.

Level: Set the user level to Operator or Guest. Different user levels have different operating permission.

- **Operator:** The *Operator* user level has permission of Two-way Audio in Remote Configuration and all operating permission in Camera Configuration by default.
- **Guest:** The *Guest* user has no permission of Two-way Audio in Remote Configuration and only has the local/remote playback in the Camera Configuration by default.

User's MAC Address: The MAC address of the remote PC which logs onto the NVR. If it is configured and enabled, it only allows the remote user with this MAC address to access the NVR.

4. Click the **OK** button to save the settings and go back to the User Management interface. The added new user will be displayed on the list, as shown in Figure 15. 6.

No.	User Name	Level	User's MAC Address	Pe...	Edit	Del...
1	admin	Admin	00:00:00:00:00:00	-		
2	01	Operator	00:00:00:00:00:00			

Figure 15. 6 Added User Listed in User Management Interface

5. Select the user from the list and then click the button to enter the Permission settings interface, as shown in Figure 15. 7.



Figure 15. 7 User Permission Settings Interface

6. Set the operating permission of Local Configuration, Remote Configuration and Camera Configuration for the user.

Local Configuration

- Local Log Search: Searching and viewing logs and system information of NVR.
- Local Parameters Settings: Configuring parameters, restoring factory default parameters and importing/exporting configuration files.
- Local Camera Management: The adding, deleting and editing of IP cameras.
- Local Advanced Operation: Operating HDD management (initializing HDD, setting HDD property), upgrading system firmware, clearing I/O alarm output.
- Local Shutdown Reboot: Shutting down or rebooting the NVR.

Remote Configuration

- Remote Log Search: Remotely viewing logs that are saved on the NVR.
- Remote Parameters Settings: Remotely configuring parameters, restoring factory default parameters and importing/exporting configuration files.
- Remote Camera Management: Remote adding, deleting and editing of the IP cameras.
- Remote Serial Port Control: Configuring settings for RS-232 and RS-485 ports.
- Remote Video Output Control: Sending remote button control signal.
- Two-Way Audio: Realizing two-way radio between the remote client and the NVR.
- Remote Alarm Control: Remotely arming (notify alarm and exception message to the remote client) and controlling the alarm output.
- Remote Advanced Operation: Remotely operating HDD management (initializing HDD, setting HDD property), upgrading system firmware, clearing I/O alarm output.
- Remote Shutdown/Reboot: Remotely shutting down or rebooting the NVR.

Camera Configuration

- Remote Live View: Remotely viewing live video of the selected camera (s).
- Local Manual Operation: Locally starting/stopping manual recording and alarm output of the selected camera (s).
- Remote Manual Operation: Remotely starting/stopping manual recording and alarm output of the selected camera (s).
- Local Playback: Locally playing back recorded files of the selected camera (s).
- Remote Playback: Remotely playing back recorded files of the selected camera (s).
- Local PTZ Control: Locally controlling PTZ movement of the selected camera (s).
- Remote PTZ Control: Remotely controlling PTZ movement of the selected camera (s).
- Local Video Export: Locally exporting recorded files of the selected camera (s).

7. Click the **OK** button to save the settings and exit interface.



Only the *admin* user account has the permission of restoring factory default parameters.

15.4.2 Deleting a User

Steps:

1. Enter the User Management interface.
Menu > Configuration > User
2. Select the user to be deleted from the list, as shown in Figure 15. 8.

No.	User Name	Level	User's MAC Address	Pe...	Edit	Del...
1	admin	Admin	00:00:00:00:00:00	-		-
2	01	Operator	00:00:00:00:00:00			

Figure 15. 8 User List

3. Click the icon to delete the selected user account.

15.4.3 Editing a User

For the added user accounts, you can edit the parameters.

Steps:

1. Enter the User Management interface.
Menu > Configuration > User
2. Select the user to be edited from the list, as shown in Figure 15. 8.
3. Click the icon to enter the Edit User interface, as shown in Figure 15. 10.

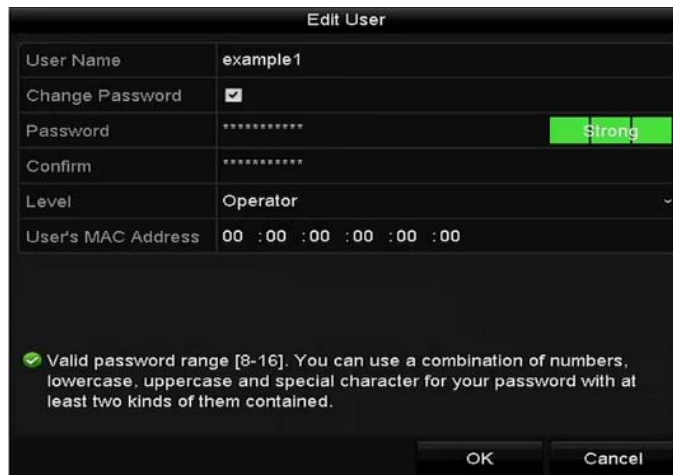

Figure 15. 9 Edit User (Operator/Guest)

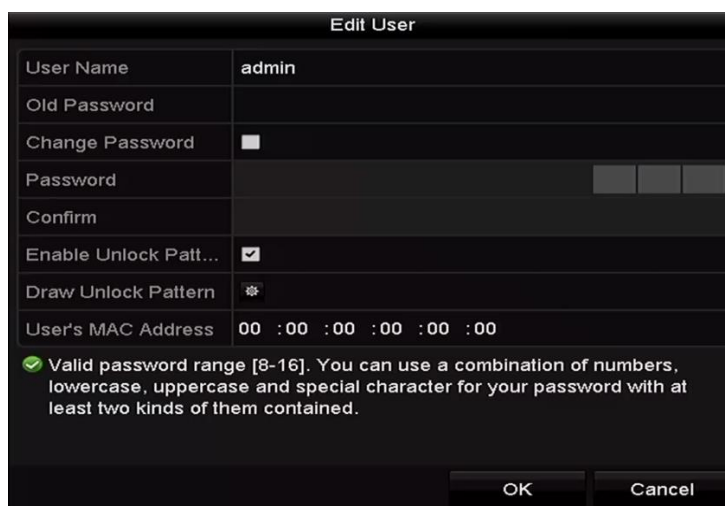

Figure 15. 10 Edit User (admin)

4. Edit the password for the user

- **Operator and Guest**

You can edit the user information, including user name, password, permission level and MAC address. Check the checkbox of **Change Password** if you want to change the password, and input the new password in the text field of **Password** and **Confirm**. A strong password is recommended.

- **Admin**

You are only allowed to edit the password and MAC address. Check the checkbox of **Change Password** if you want to change the password, and the input the correct old password, and the new password in the text field of **Password** and **Confirm**.

⚠️ STRONG PASSWORD RECOMMENDED– *We highly recommend you create a strong password of your own choosing (using a minimum of 8 characters, including upper case letters, lower case letters, numbers, and special characters) in order to increase the security of your*

product. And we recommend you reset your password regularly, especially in the high security system, resetting the password monthly or weekly can better protect your product.

5. Edit the unlock pattern for the admin user account.
 - 1) Check the checkbox of **Enable Unlock Pattern** to enable the use of unlock pattern when logging in to the device.
 - 2) Use the mouse to draw a pattern among the 9 dots on the screen. Release the mouse when the pattern is done.



Please refer to *Chapter Configuring the Unlock Pattern* for detailed instructions.

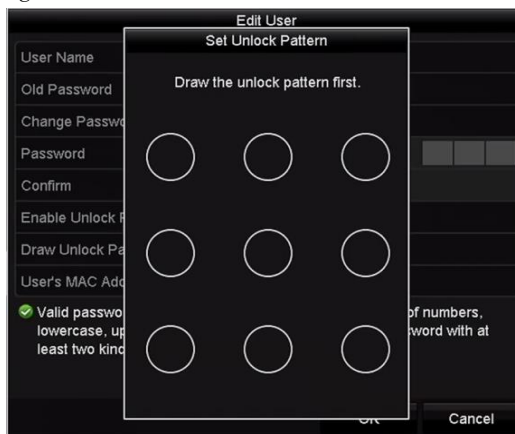



Figure 15. 11 Set Unlock Patter for Admin User

6. Click the **OK** button to save the settings and exit the menu.
7. For the **Operator** or **Guest** user account, you can also click the  button on the user management interface to edit the permission.

Chapter 16 Appendix

16.1 Glossary

- **Dual Stream:** Dual stream is a technology used to record high resolution video locally while transmitting a lower resolution stream over the network. The two streams are generated by the DVR, with the main stream having a maximum resolution of 4CIF and the sub-stream having a maximum resolution of CIF.
- **HDD:** Acronym for Hard Disk Drive. A storage medium which stores digitally encoded data on platters with magnetic surfaces.
- **DHCP:** Dynamic Host Configuration Protocol (DHCP) is a network application protocol used by devices (DHCP clients) to obtain configuration information for operation in an Internet Protocol network.
- **HTTP:** Acronym for Hypertext Transfer Protocol. A protocol to transfer hypertext request and information between servers and browsers over a network
- **DDNS:** Dynamic DNS is a method, protocol, or network service that provides the capability for a networked device, such as a router or computer system using the Internet Protocol Suite, to notify a domain name server to change, in real time (ad-hoc) the active DNS configuration of its configured hostnames, addresses or other information stored in DNS.
- **Hybrid DVR:** A hybrid DVR is a combination of a DVR and NVR.
- **NTP:** Acronym for Network Time Protocol. A protocol designed to synchronize the clocks of computers over a network.
- **NTSC:** Acronym for National Television System Committee. NTSC is an analog television standard used in such countries as the United States and Japan. Each frame of an NTSC signal contains 525 scan lines at 60Hz.
- **NVR:** Acronym for Network Video Recorder. An NVR can be a PC-based or embedded system used for centralized management and storage for IP cameras, IP Domes and other DVRs.
- **PAL:** Acronym for Phase Alternating Line. PAL is also another video standard used in broadcast televisions systems in large parts of the world. PAL signal contains 625 scan lines at 50Hz.
- **PTZ:** Acronym for Pan, Tilt, Zoom. PTZ cameras are motor driven systems that allow the camera to pan left and right, tilt up and down and zoom in and out.
- **USB:** Acronym for Universal Serial Bus. USB is a plug-and-play serial bus standard to interface devices to a host computer.

16.2 Troubleshooting

- **No image displayed on the monitor after starting up normally.**

Possible Reasons

- No VGA or HDMI connections.
- Connection cable is damaged.
- Input mode of the monitor is incorrect.

Steps

- Verify the device is connected with the monitor via HDMI or VGA cable.
If not, please connect the device with the monitor and reboot.
- Verify the connection cable is good.
If there is still no image display on the monitor after rebooting, please check if the connection cable is good, and change a cable to connect again.
- Verify Input mode of the monitor is correct.
Please check the input mode of the monitor matches with the output mode of the device (e.g. if the output mode of NVR is HDMI output, then the input mode of monitor must be the HDMI input). And if not, please modify the input mode of monitor.
- Check if the fault is solved by the step 1 to step 3.
If it is solved, finish the process.
If not, please contact the engineer from our company to do the further process.

- **There is an audible warning sound “Di-Di-Di-DiDi” after a new bought NVR starts up.**

Possible Reasons

- No HDD is installed in the device.
- The installed HDD has not been initialized.
- The installed HDD is not compatible with the NVR or is broken-down.

Steps

- Verify at least one HDD is installed in the NVR.
 - If not, please install the compatible HDD.
-  Please refer to the “Quick Operation Guide” for the HDD installation steps.
- If you don't want to install a HDD, select “Menu>Configuration > Exceptions”, and uncheck the Audible Warning checkbox of “HDD Error”.
 - Select “Menu>HDD>General”.
 - If the status of the HDD is “Uninitialized”, please check the checkbox of corresponding HDD and click the “Init” button.
 - Verify the HDD is initialized.
 - Select “Menu>HDD>General”.
 - If the HDD is not detected or the status is “Abnormal”, please replace the dedicated HDD according to the requirement.
 - Check if the fault is solved by the step 1 to step 3.
If it is solved, finish the process.
If not, please contact the engineer from our company to do the further process.

- **The status of the added IP camera displays as “Disconnected” when it is connected through Private**

Protocol. Select “Menu>Camera>Camera>IP Camera” to get the camera status.

Possible Reasons

- a) Network failure, and the NVR and IP camera lost connections.
- b) The configured parameters are incorrect when adding the IP camera.
- c) Insufficient bandwidth.

Steps

1. Verify the network is connected.
 - 1) Connect the NVR and PC with the RS-232 cable.
 - 2) Open the Super Terminal software, and execute the ping command. Input “ping IP” (e.g. ping 172.6.22.131).



Simultaneously press **Ctrl** and **C** to exit the ping command.

If there exists return information and the time value is little, the network is normal.

2. Verify the configuration parameters are correct.
 - 1) Select “Menu>Camera>Camera>IP Camera”.
 - 2) Verify the following parameters are the same with those of the connected IP devices, including IP address, protocol, management port, user name and password.
3. Verify the whether the bandwidth is enough.
 - 1) Select “Menu >Maintenance > Net Detect > Network Stat.”.
 - 2) Check the usage of the access bandwidth, and see if the total bandwidth has reached its limit.
4. Check if the fault is solved by the step 1 to step 3.

If it is solved, finish the process.

If not, please contact the engineer from our company to do the further process.

- **The IP camera frequently goes online and offline and the status of it displays as “Disconnected”.**

Possible Reasons

- a) The IP camera and the NVR versions are not compatible.
- b) Unstable power supply of IP camera.
- c) Unstable network between IP camera and NVR.
- d) Limited flow by the switch connected with IP camera and NVR.

Steps

1. Verify the IP camera and the NVR versions are compatible.
 - 1) Enter the IP camera Management interface “Menu > Camera > Camera>IP Camera”, and view the firmware version of connected IP camera.
 - 2) Enter the System Info interface “Menu>Maintenance>System Info>Device Info”, and view the firmware version of NVR.
2. Verify power supply of IP camera is stable.
 - 1) Verify the power indicator is normal.
 - 2) When the IP camera is offline, please try the ping command on PC to check if the PC connects with the IP camera.
3. Verify the network between IP camera and NVR is stable.
 - 1) When the IP camera is offline, connect PC and NVR with the RS-232 cable.
 - 2) Open the Super Terminal, use the ping command and keep sending large data packages to the connected IP camera, and check if there exists packet loss.



Simultaneously press **Ctrl** and **C** to exit the ping command.

Example: Input **ping 172.6.22.131 -l 1472 -f**.

4. Verify the switch is not flow control.
Check the brand, model of the switch connecting IP camera and NVR, and contact with the manufacturer of the switch to check if it has the function of flow control. If so, please turn it down.
5. Check if the fault is solved by the step 1 to step 4.
If it is solved, finish the process.
If not, please contact the engineer from our company to do the further process.

- **No monitor connected with the NVR locally and when you manage the IP camera to connect with the device by web browser remotely, of which the status displays as Connected. And then you connect the device with the monitor via VGA or HDMI interface and reboot the device, there is black screen with the mouse cursor.**

Connect the NVR with the monitor before startup via VGA or HDMI interface, and manage the IP camera to connect with the device locally or remotely, the status of IP camera displays as Connect. And then connect the device with the CVBS, and there is black screen either.

Possible Reasons:

After connecting the IP camera to the NVR, the image is output via the main spot interface by default.

Steps:

1. Enable the output channel.
2. Select “Menu > Configuration > Live View > View”, and select video output interface in the drop-down list and configure the window you want to view.



- The view settings can only be configured by the local operation of NVR.
 - Different camera orders and window-division modes can be set for different output interfaces separately, and digits like “D1” and “D2” stands for the channel number, and “X” means the selected window has no image output.
3. Check if the fault is solved by the above steps.
If it is solved, finish the process.
If not, please contact the engineer from our company to do the further process.

- **Live view stuck when video output locally.**

Possible Reasons:

- a) Poor network between NVR and IP camera, and there exists packet loss during the transmission.
- b) The frame rate has not reached the real-time frame rate.

Steps:

1. Verify the network between NVR and IP camera is connected.
 - 1) When image is stuck, connect the RS-232 ports on PC and the rear panel of NVR with the RS-232 cable.
 - 2) Open the Super Terminal, and execute the command of “**ping 192.168.0.0 -l 1472 -f**” (the IP address may change according to the real condition), and check if there exists packet loss.



Simultaneously press **Ctrl** and **C** to exit the ping command.

2. Verify the frame rate is real-time frame rate.
Select “Menu > Record > Parameters > Record”, and set the Frame rate to Full Frame.
3. Check if the fault is solved by the above steps.
If it is solved, finish the process.
If not, please contact the engineer from our company to do the further process.

- **Live view stuck when video output remotely via the Internet Explorer or platform software.**

Possible Reasons:

- a) Poor network between NVR and IP camera, and there exists packet loss during the transmission.
- b) Poor network between NVR and PC, and there exists packet loss during the transmission.
- c) The performances of hardware are not good enough, including CPU, memory, etc.

Steps:

1. Verify the network between NVR and IP camera is connected.
 - 1) When image is stuck, connect the RS-232 ports on PC and the rear panel of NVR with the RS-232 cable.
 - 2) Open the Super Terminal, and execute the command of “**ping 192.168.0.0 -l 1472 -f**” (the IP address may change according to the real condition), and check if there exists packet loss.



Simultaneously press **Ctrl** and **C** to exit the ping command.

2. Verify the network between NVR and PC is connected.
 - 1) Open the cmd window in the Start menu, or you can press “windows+R” shortcut key to open it.
 - 2) Use the ping command to send large packet to the NVR, execute the command of “**ping 192.168.0.0 -l 1472 -f**” (the IP address may change according to the real condition), and check if there exists packet loss.



Simultaneously press **Ctrl** and **C** to exit the ping command.

3. Verify the hardware of the PC is good enough.

Simultaneously press **Ctrl**, **Alt** and **Delete** to enter the windows task management interface, as shown in the following figure.

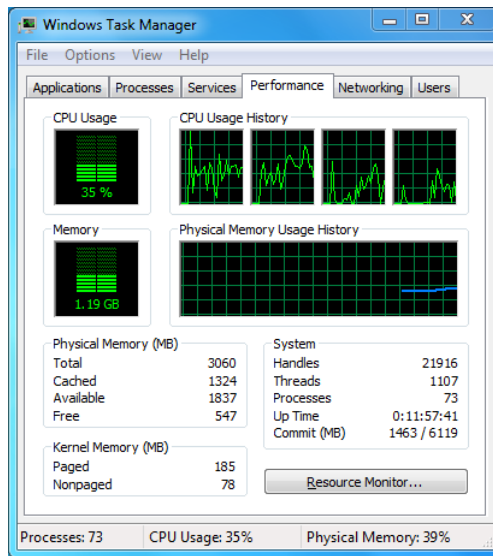

Windows task management interface

- Select the “Performance” tab; check the status of the CPU and Memory.
 - If the resource is not enough, please end some unnecessary processes.
4. Check if the fault is solved by the above steps.

If it is solved, finish the process.

If not, please contact the engineer from our company to do the further process.

- **When using the NVR to get the live view audio, there is no sound or there is too much noise, or the volume is too low.**

Possible Reasons:

- a) Cable between the pickup and IP camera is not connected well; impedance mismatches or incompatible.
- b) The stream type is not set as “Video & Audio”.
- c) The encoding standard is not supported with NVR.

Steps:

1. Verify the cable between the pickup and IP camera is connected well; impedance matches and compatible.
Log in the IP camera directly, and turn the audio on, check if the sound is normal. If not, please contact the manufacturer of the IP camera.
2. Verify the setting parameters are correct.
Select “Menu > Record > Parameters > Record”, and set the Stream Type as “Audio & Video”.
3. Verify the audio encoding standard of the IP camera is supported by the NVR.
NVR supports G722.1 and G711 standards, and if the encoding parameter of the input audio is not one of the previous two standards, you can log in the IP camera to configure it to the supported standard.
4. Check if the fault is solved by the above steps.
If it is solved, finish the process.
If not, please contact the engineer from our company to do the further process.

- **The image gets stuck when NVR is playing back by single or multi-channel.**

Possible Reasons:

- a) Poor network between NVR and IP camera, and there exists packet loss during the transmission.
- b) The frame rate is not the real-time frame rate.
- c) The NVR supports up to 16-channel synchronize playback at the resolution of 4CIF, if you want a 16-channel synchronize playback at the resolution of 720p, the frame extracting may occur, which leads to a slight stuck.

Steps:

1. Verify the network between NVR and IP camera is connected.
 - 1) When image is stuck, connect the RS-232 ports on PC and the rear panel of NVR with the RS-232 cable.
 - 2) Open the Super Terminal, and execute the command of “**ping 192.168.0.0 -l 1472 -f**” (the IP address may change according to the real condition), and check if there exists packet loss.



Simultaneously press the **Ctrl** and **C** to exit the ping command.

2. Verify the frame rate is real-time frame rate.
Select “Menu > Record > Parameters > Record”, and set the Frame Rate to “Full Frame”.
3. Verify the hardware can afford the playback.
Reduce the channel number of playback.
Select “Menu > Record > Encoding > Record”, and set the resolution and bitrate to a lower level.
4. Reduce the number of local playback channel.
Select “Menu > Playback”, and uncheck the checkbox of unnecessary channels.
5. Check if the fault is solved by the above steps.
If it is solved, finish the process.
If not, please contact the engineer from our company to do the further process.

- **No record file found in the NVR local HDD, and prompt “No record file found”.**

Possible Reasons:

- a) The time setting of system is incorrect.
- b) The search condition is incorrect.
- c) The HDD is error or not detected.

Steps:

1. Verify the system time setting is correct.
Select “Menu > Configuration > General > General”, and verify the “Device Time” is correct.
2. Verify the search condition is correct.
Select “Playback”, and verify the channel and time are correct.
3. Verify the HDD status is normal.
Select “Menu > HDD > General” to view the HDD status, and verify the HDD is detected and can be read and written normally.
4. Check if the fault is solved by the above steps.
If it is solved, finish the process.
If not, please contact the engineer from our company to do the further process.

16.3 List of Compatible IP Cameras



- For the list, our company holds right to interpret.
- **ONVIF compatibility** refers to the camera can be supported both when it uses the ONVIF protocol and its private protocols. **Only ONVIF is supported** refers to the camera can only be supported when it uses the ONVIF protocol. **Only AXIS is supported** refers to the function can only be supported when it uses the AXIS protocol.

IP Camera Manufacturer or Protocol	Model	Version	Max. Resolution	Sub-stream	Audio
ACTi	ACM3401-09L-X-00227	A1D-220-V3.13.16-AC	1208*1024	×	×
	TCM4301-10D-X-00083	A1D-310-V4.12.09-AC	1208*1024	×	√
	TCM5311-11D-X-00023	A1D-310-V4.12.09-AC	1208*960	×	√
Arecont	AV1305 M	65175	1208*1024	√	×
	AV2815	65220	1920*1080	√	×
	AV3105M	65175	1920*1080	√	×
	AV8185DN	65172	1600*1200	×	×
Axis	M1114	5.09.1	1024*640	√	×
	M3011(ONVIF compatibility)	5.21	640*480 (704*576)	√(×)	×
	M3014(ONVIF compatibility)	5.21.1	1280*800	√	×
	P1346	5.40.9.2	2048*1536	√	√
	P3301(ONVIF compatibility)	5.11.2	640*480 (768*576)	√	√(×)
	P3304(ONVIF compatibility)	5.20	1280*800 (1440*900)	√	√(×)
	P3343(ONVIF compatibility)	5.20.1	800*600	√	√(×)
	P3344(ONVIF compatibility)	5.20.1	1280*800 (1440*900)	√	√(×)
	P5532	5.15	720*576	√	×
	Q7404	5.02	720*576	√	√
Bosch	AutoDome Jr 800 HD (ONVIF compatibility)	39500450	1920*1080	×	√(×)
	Dinion NBN-921-P (ONVIF compatibility)	10500453	1280*720	×	√(×)
	NBC 265 P (ONVIF compatibility)	07500452	1280*720	×	√(×)

IP Camera Manufacturer or Protocol	Model	Version	Max. Resolution	Sub-stream	Audio
Brickcom	CB-500Ap(Brickcom-50xA) (ONVIF compatibility)	v3.2.1.3	1920*1080	×	√(×)
Canon	VB-H410(ONVIF compatibility)	Ver.+1.0.0	1920*1080 (1280*960)	×	√
	VB-S9000F	Ver. 1.0.0	1920*1080	×	×
	VB-S300D	Ver. 1.0.0	1920*1080	×	×
	VB-H6100D	Ver. 1.0.0	1920*1080	×	×
	VB-H7100F	Ver. 1.0.0	1920*1080	×	√
	VB-S8000	Ver. 1.0.0	1920*1080	×	×
Panasonic	SP306H (ONVIF compatibility)	Application:1.34 Image data:1.06	1280*960	√(×)	√
	SF336H	Application:1.06 Image data: 1.06	1280*960	√	√
Pelco	D5118 (ONVIF compatibility)	1.8.2-20120327-2.9310-A1.7852	1280*960	√	×
	IX30DN-ACFZHB3 (ONVIF compatibility)	1.8.2-20120327-2.9080-A1.7852	2048*1536	√	×
	IXE20DN-AAXVUU2 (ONVIF compatibility)	1.8.2-20120327-2.9081-A1.7852	1920*1080	√	×
Sanyo	2300P(with lens)	2.03-02 (110318-00)	1920*1080	×	×
	2500P(with lens)	2.02-02 (110208-00)	1920*1080	×	√
	4600P	2.03-02 (110315-00)	1920*1080	×	√
SONY	SNC-CH220	1.50.00	1920*1080	×	×
	SNC DH220T (ONVIF only)	1.50.00	2048*1536	×	×
	SNC-EP580 (ONVIF compatibility)	1.53.00	1920*1080	√	√
	SNC-RH124 (ONVIF compatibility)	1.79.00	1280*720	√	√
SUMSUNG	SND-5080 (ONVIF compatibility)	3.10_130416	1280*1024	√	√
Vivotek	IP7133	0203a	640*480	×	×
	FD8134 (ONVIF compatibility)	0107a	1280*800	×	×
	IP8161 (ONVIF compatibility)	0104a	1600*1200	×	√(×)
	IP8331 (ONVIF compatibility)	0102a	640*480	×	×
	IP8332	0105b	1280*800	×	×

IP Camera Manufacturer or Protocol	Model	Version	Max. Resolution	Sub-stream	Audio
	(ONVIF compatibility)				
Zavio	D5110 (ONVIF compatibility)	MG.1.6.03P8	1280*1024	√ (×)	×
	F3106 (ONVIF compatibility)	M2.1.6.03P8	1280*1024	√ (×)	√
	F3110 (ONVIF compatibility)	M2.1.6.01	1280*720	√ (×)	√
	F3206 (ONVIF compatibility)	MG.1.6.02c045	1920*1080	√ (×)	√
	F531E (ONVIF compatibility)	LM.1.6.18P10	640*480	√ (×)	√